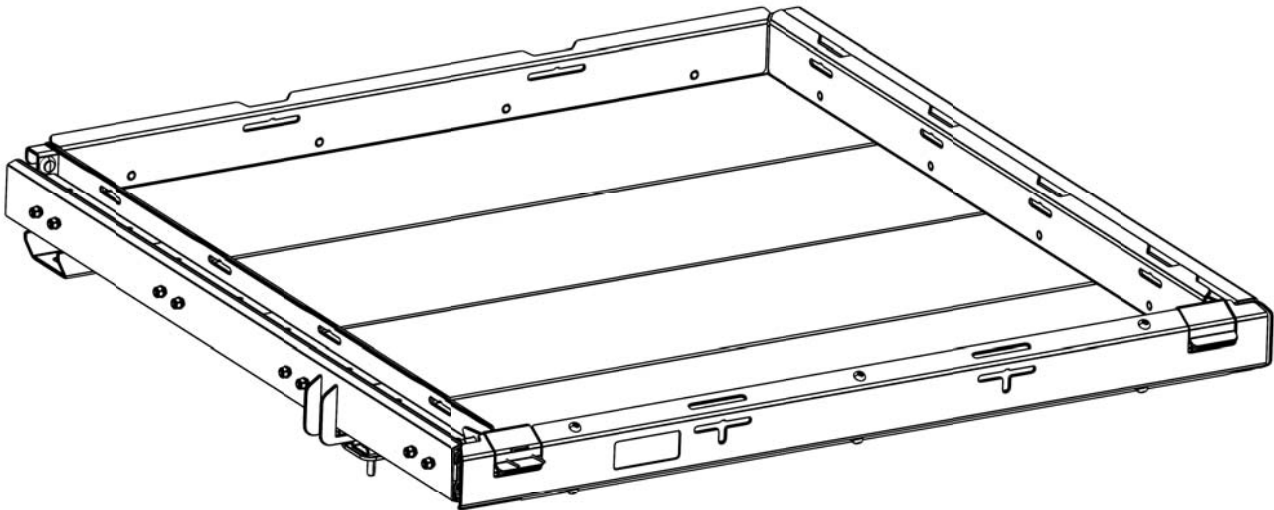

**INSTALL TIME: 45 mins**

IMPORTANT WARNING!

IT IS CRITICAL THAT ALL FRONT RUNNER PRODUCTS BE PROPERLY AND SECURELY ASSEMBLED AND ATTACHED TO YOUR VEHICLE. IMPROPER ATTACHMENT COULD RESULT IN AN AUTOMOBILE ACCIDENT, AND COULD CAUSE SERIOUS BODILY INJURY OR DEATH TO YOU OR TO OTHERS. YOU ARE RESPONSIBLE FOR ASSEMBLING AND SECURING ALL FRONT RUNNER PRODUCTS TO YOUR VEHICLE, CHECKING THE ATTACHMENTS PRIOR TO USE, AND PERIODICALLY INSPECTING THE PRODUCTS FOR ADJUSTMENT, WEAR, AND DAMAGE. THEREFORE, YOU MUST READ AND UNDERSTAND ALL OF THE INSTRUCTIONS AND CAUTIONS SUPPLIED WITH YOUR FRONT RUNNER PRODUCT PRIOR TO INSTALLATION OR USE. IF YOU DO NOT UNDERSTAND ALL OF THE INSTRUCTIONS AND CAUTIONS, OR IF YOU HAVE NO MECHANICAL EXPERIENCE AND ARE NOT THOROUGHLY FAMILIAR WITH THE INSTALLATION PROCEDURES, YOU SHOULD HAVE THE PRODUCT INSTALLED BY A PROFESSIONAL INSTALLER OR OTHER QUALIFIED PERSONNEL.

1

GET ORGANIZED...

Here is what you are looking at:

Item #	Quantity	Description
1	1	CARGO SLIDE
2	1	FRONT MOUNTING STRAP *
3	4	M6 x 30 BUTTON HEAD BOLT
4	4	M6 SPRING WASHER
5	4	M6 x 19 x 1 FLAT WASHER
6	2	M6 RIVNUT *
7	2	M6 x 40 BUTTON HEAD BOLT*

* Only used when installing Cargo Slide to vehicles with removable speaker box. Refer to the bottom of Page 3.

- You will need:**
- 4 mm Hex Key
 - Marking Pen
 - Utility Knife
 - A Friend
 - Insulation & Masking Tape *
 - 9 mm Drill Bit *
 - Drill Machine *
 - Rivnut Gun *
- * Only used when installing Cargo Slide to vehicles with removable speaker box. Refer to the bottom of Page 3.

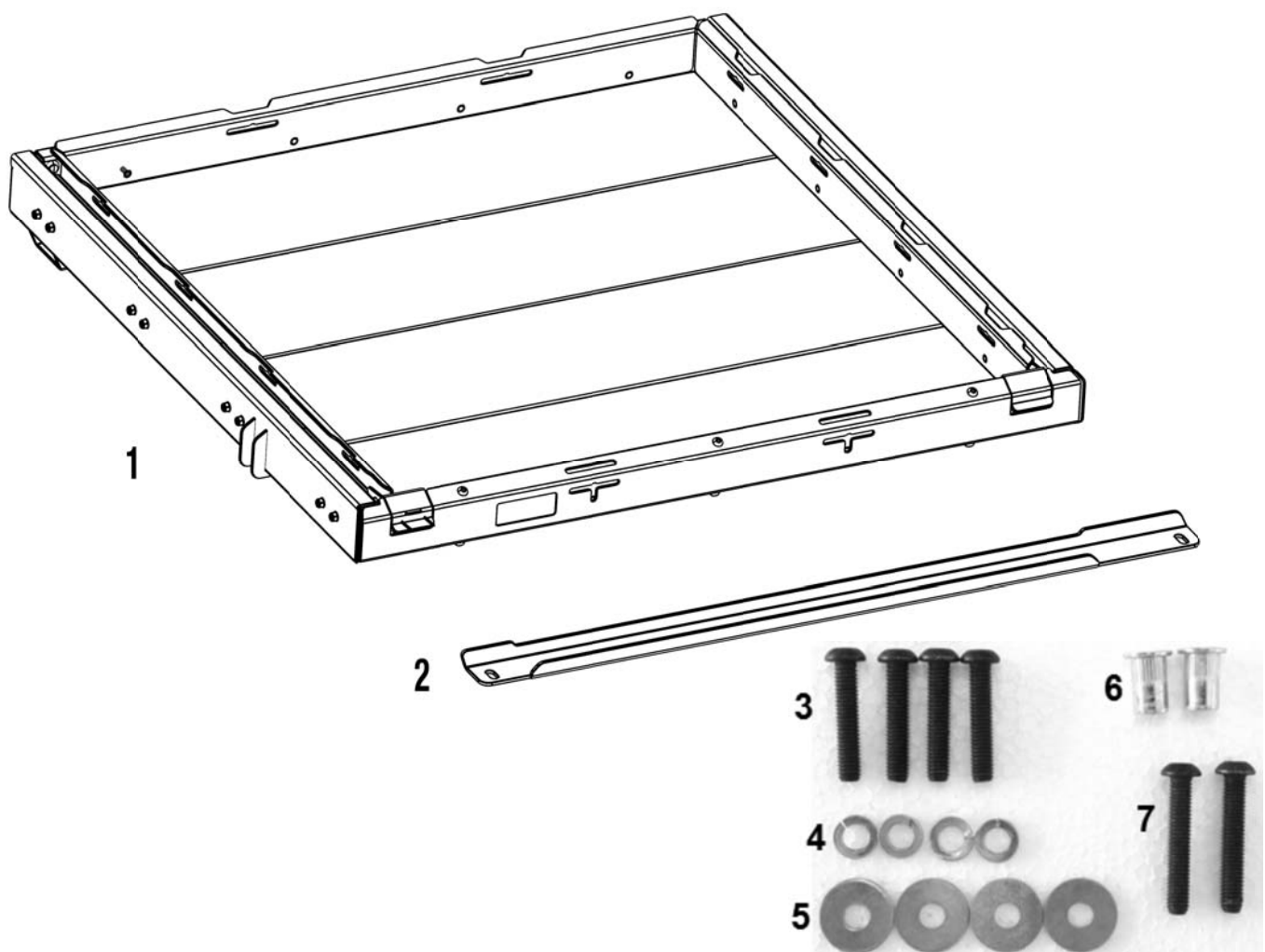

(A) Familiarize yourself with the parts and then step away from the work area and read through these instructions from beginning to end. Grab a cup of coffee and take a moment. A little prep now may save you a lot of time later.

1 GET ORGANIZED CONT...

- (B) Remove the vehicle's jack and place it in the parcel bin that runs from left to right at the rear of the vehicle. Refit plastic moulding.

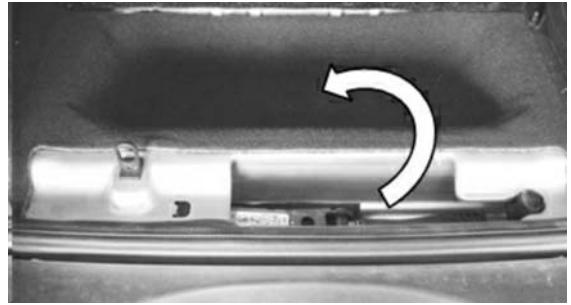

- (C) Once your Cargo Slide has been removed from its packaging, turn the Cargo Slide upside down so that the wooden base is facing upwards. Ensure this is done on a suitable surface as not to scratch your Cargo Slide. Loosen and remove the the wooden base by loosening the three bolts as indicated by the arrows. The three bolts and corresponding nuts may be discarded.

The wooden base may be kept and used as a "liner" for your Cargo Slide as shown below .

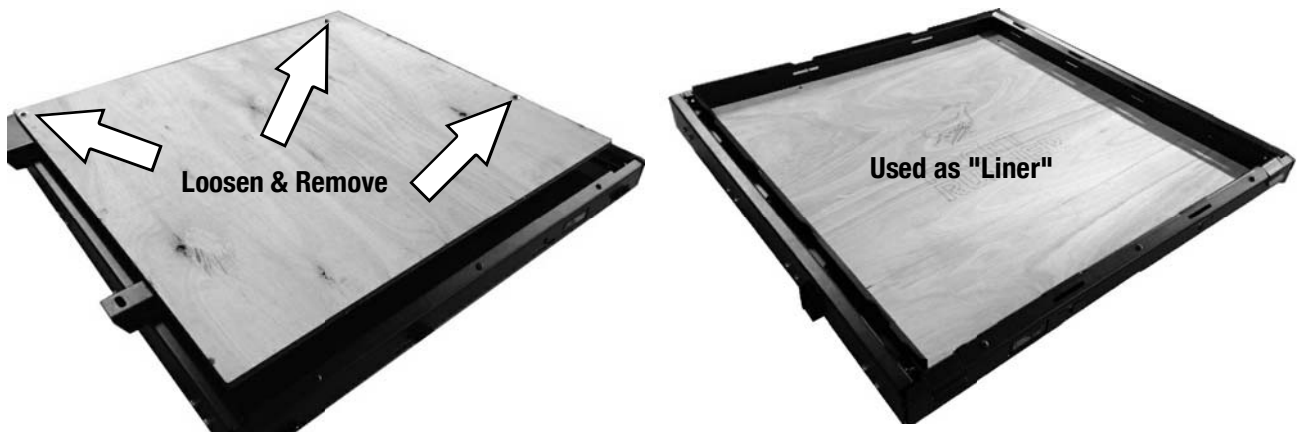

If your vehicle's rear interior is the same as the image below, with the removable speaker, please proceed to Section 3 starting on Page 6.

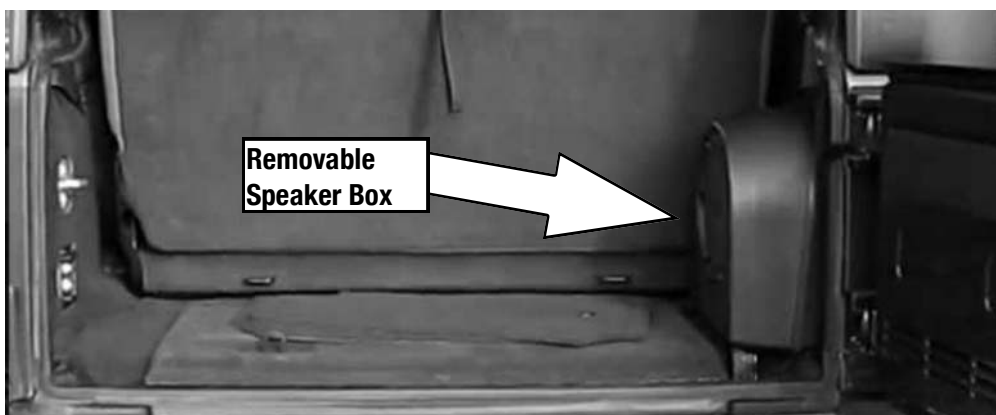

2 INSTALL THE CARGO SLIDE

- (A) Drop down the rear seats. Remove the rear storage cover. Using a 4mm hex key, remove the four D-rings, two behind the passenger seats, one next to the base of the speaker and one opposite.

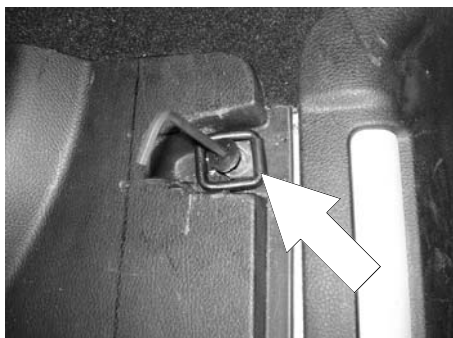

- (B) With the help of a friend, lift the Cargo Slide (Item 1) into the vehicle, lining up the the four mounting points in the base of the Cargo Slide with the four mounting points from Step 2A. Take care not to scratch the interior of the vehicle.

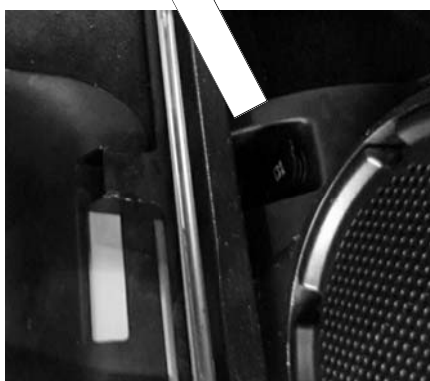
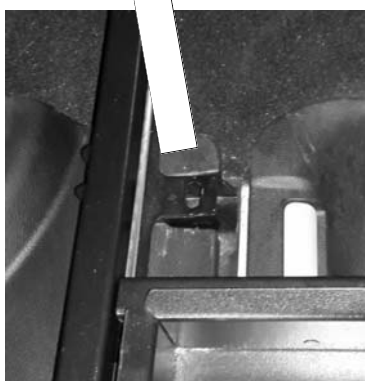
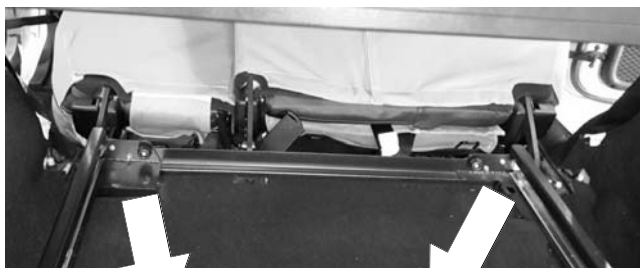

On certain models, it may be required to relieve the corners of the plastic recesses to allow the Cargo Slide's mounting feet to fit.

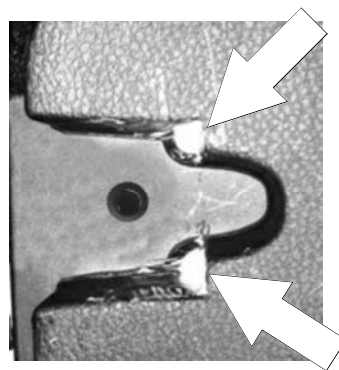

2 INSTALL THE CARGO SLIDE CONT...

- (C) Open the Slider slightly to gain access to the rear mounts. Do not open the slider more than is needed as it will lift up and forward and could result in damage to the vehicle. Mark the outline of the left and right rear mounting feet onto the carpet using a suitable marker. Move the Cargo Slide out of the way towards the rear of the vehicle. Using a utility knife, cut three sides of the carpet allowing the carpet to create a flap/hinge as shown.

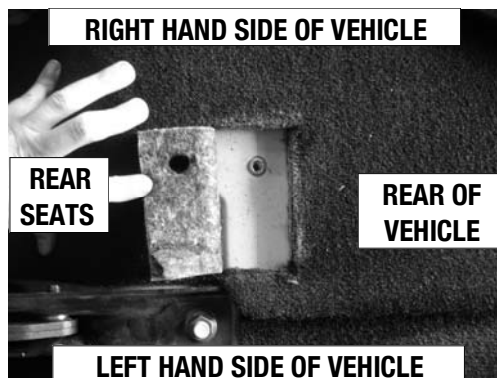
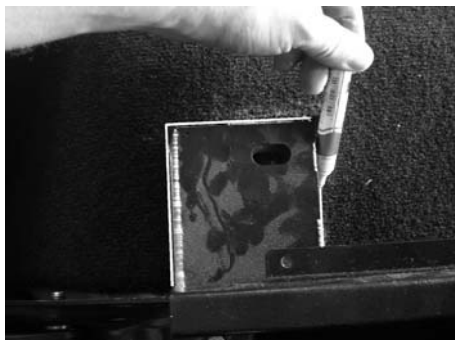

- (D) Place the Cargo Slider back into position lining up the four mounting points (Refer to Steps 2A & 2B). Flap the two pieces of carpet from Step 2C over, so that the rear mounting feet are hand mounted against the vehicle's body. Hand tighten the Slider into position using the M6 x30 Button Head Bolts, M6 Spring Washers and M6 x19 x1 Flat Washers (Items 3, 4, 5) supplied. Start with the front right corner next to the speaker box as shown. Fasten the two rear mountings, working in an anti-clockwise direction. Remember not to open the Slider further than required when gaining access to the rear mounts as it may lift and cause damage to your vehicle.

After the rear mountings are secure, open the Slider to gain access and fasten the front left mounting. Once all four mountings are hand tight, close the Slider and push the whole assembly as far forward as possible. Check that the tailgate closes without hitting the Slider. Go back and tighten all four mounting bolts.

Should the Sliding Tray have any play, front to back, when in the closed position, please refer to Page 9 Step 4 on how to adjust the rubber stoppers.

Congratulations, you have completed your installation. Take a step back and admire your work. Good Job!

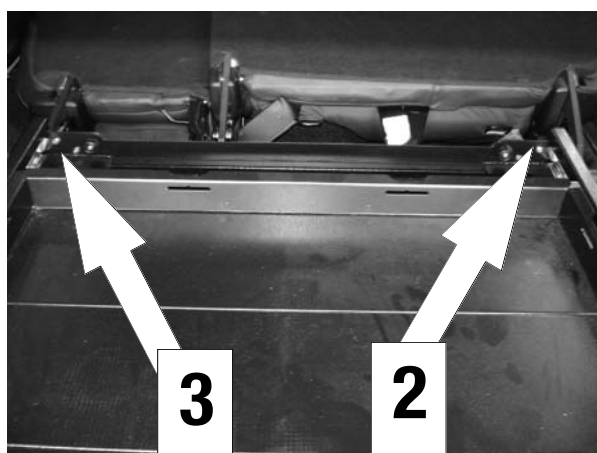
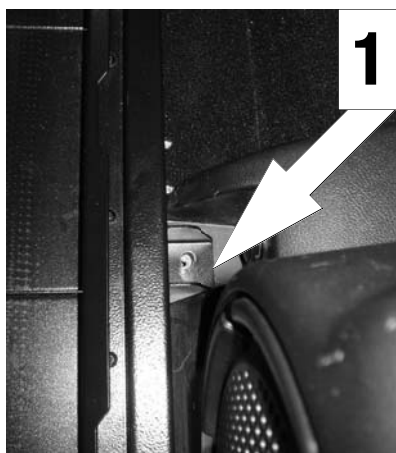

3 INSTALL THE CARGO SLIDE

- (A) Locate the speaker box found on the right hand side of the vehicle and loosen the three nuts as indicated by the arrows. Lift the speaker box free from its mounting studs and disconnect the speaker cables found at the rear of the speaker box.

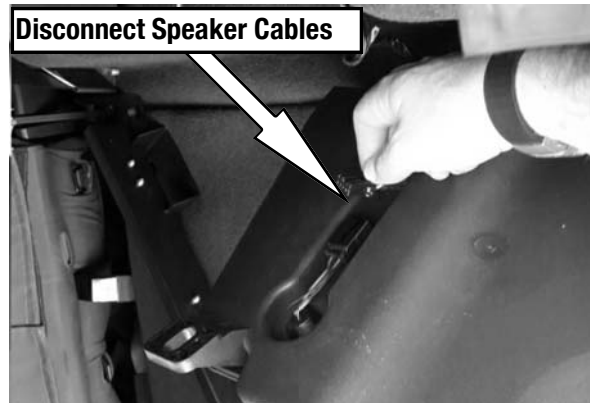
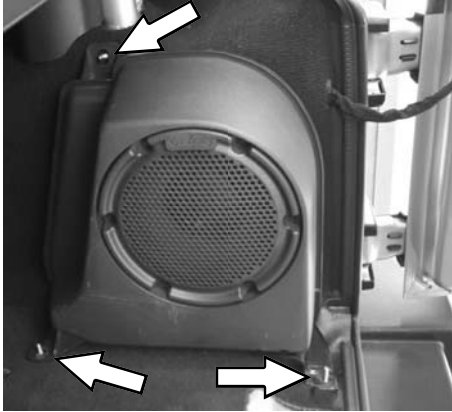

- (B) Remove the speaker box from the vehicle. Using masking tape, tape the area around the bottom left hand "mounting foot". Working on a suitable surface as not to scratch the speaker box, cutoff / remove the bottom left hand "mounting foot" as shown below. Refit speaker box to vehicle.

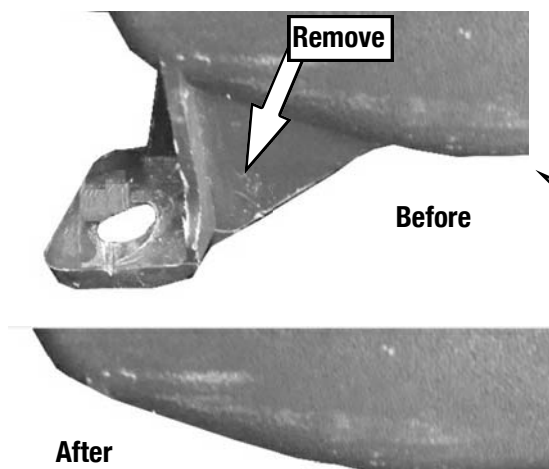

- (C) Drop down the rear seats and remove the rear storage cover. Using a 4 mm hex key, remove the two D-rings found behind the rear passenger seats. If your vehicle does not have the D-rings there will be two threaded mounting points covered by plastic caps found in the same location. remove the plastic caps to expose the threaded mounting points.



3 INSTALL THE CARGO SLIDE CONT...

- (D) With the help of a friend, lift the Cargo Slide into the vehicle, taking care not to damage the vehicle. Open the Slider slightly to gain access to the rear mounting feet, as indicated by the arrows. Do not open the slider more than is needed as it will lift up and forward and could result in damage to the vehicle. Line the holes in the rear mounting feet up with the two mounting points from Step 3C.

Loosely secure the two rear mounting feet to the vehicle using two M6 x 30 Button Head Bolts, two M6 Spring Washers and two M6 x 19 x 1 Flat Washers (Items 3, 4, 5) supplied.

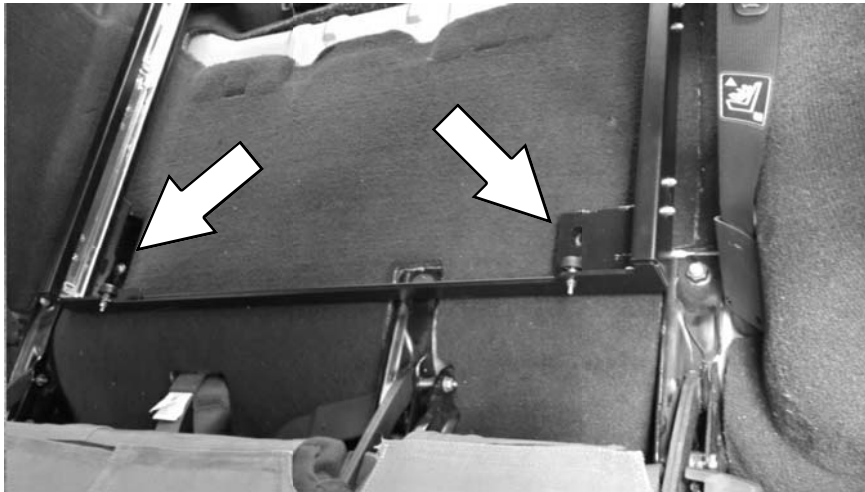

- (E) Open the Cargo Slide fully to expose the front mounting feet, as indicated by the arrows. Lift the front of the Cargo Slide and place the Front Mounting Strap (Items 2) underneath the mounting feet as shown.

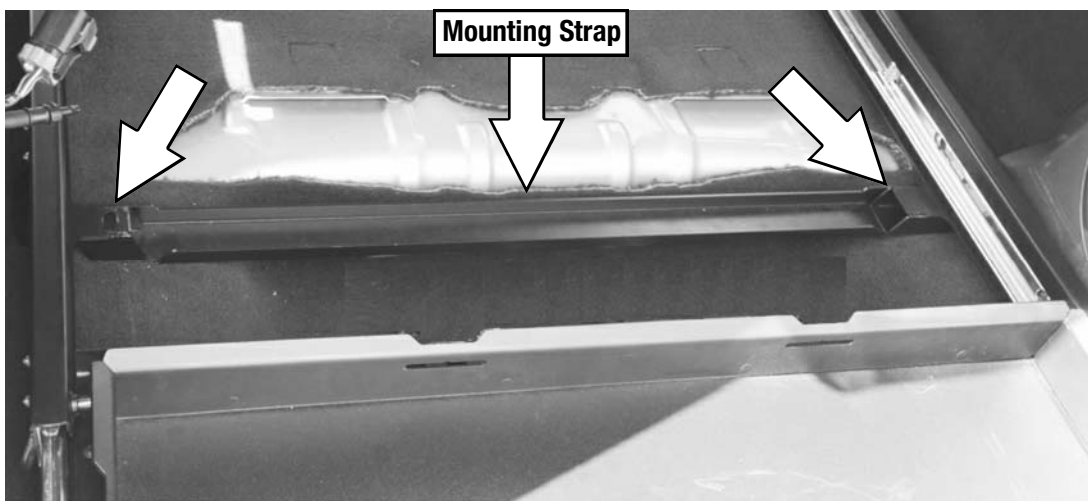

- (F) Close the Cargo Slide and position it so as to sufficiently clear the rear door when closed. Once you are happy with the position of the Cargo Slide, carefully open the Slide as not to move its position and mark the location of the front mounting points (Refer to Step 3E) onto the vehicle's carpet.

3 INSTALL THE CARGO SLIDE CONT...

- (G) Mark the outline of the rear mounting feet onto the carpet using a suitable marker. Loosen the two rear bolts securing the Cargo Slide to the vehicle and remove the Cargo Slide and Strap from the vehicle. Using a utility knife, cut three sides of the carpet allowing the carpet to create a flap/hinge as shown.

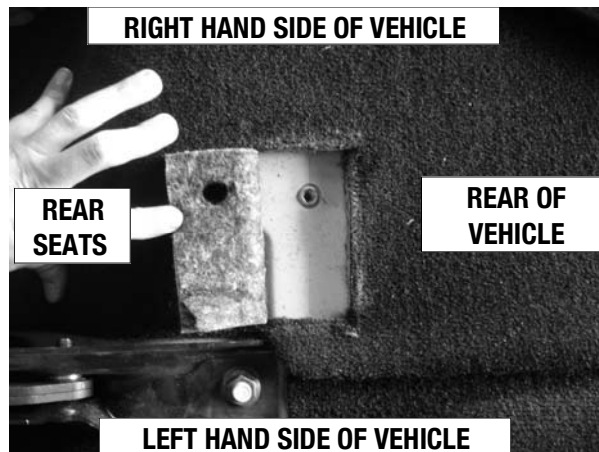

- (H) You will now need to drill two holes in the vehicle's body and need to do a bit of prep. Take your 9 mm drill bit and using some insulation tape, wrap a band of tape around the drill bit to act as a stopper.

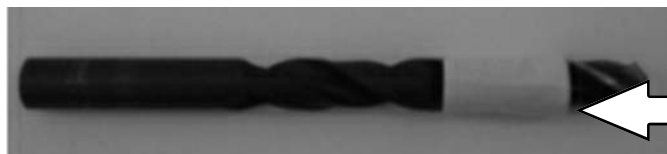

- (I) On each of your two markings from Step 3F, drill a 9 mm hole through the vehicle's carpet and body work. Insert and crimp a M6 Rivnut (Item 6) into each of the two holes.

- (J) Place the Cargo Slide back into the vehicle lining up the two rear mounting points. Flap the two pieces of carpet from Step 3G over, so that the rear mounting feet are hard mounted against the vehicle's body and loosely fasten the rear mounting feet to the vehicle as before.

Fully open the Cargo Slide and insert the Front Mounting Strap under the Cargo Slide as before (Step 3E). Loosely fasten the two front mounting feet and Strap to the vehicle using the two M6 x 40 Button Head Bolts, two M6 Spring Washers and two M6 x 19 x 1 Flat Washers (Items 4, 5, 7) supplied. Once all four mountings are hand tightened, close the Slider and push the whole assembly as far forward as possible. Check that the tailgate closes without hitting the Slider. Go back and tighten all four mounting bolts.

Should the Sliding Tray have any play, front to back, when in the closed position, please refer to Page 9 Step 4 on how to adjust the rubber stoppers.

Congratulations, you have completed your installation. Take a step back and admire your work. Good Job!

4 ADJUST RUBBER STOPPER

- (A) Working from the rear of the Slider with it in the closed position, push against the bolt attached to the Rubber Stopper (refer to arrow) so that the Stopper is pushing up against the Slider. With pressure still being applied to the bolt, fasten Nut 2 until it just touches the Flat Washer 2. Tighten Nut 1 whilst holding Nut 2 with a wrench. Repeat for opposite side.

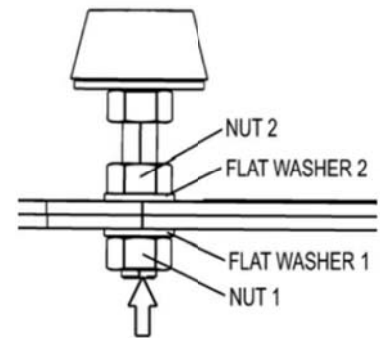

5 INSTALL OTHER VEHICLE AND RACK ACCESSORIES

- (A) Now's the time to visit your favorite Front Runner dealer in person or on-line.