



INSTALLATION INSTRUCTIONS



2007-19 TOYOTA TUNDRA 2WD/4WD 4" SYSTEM w/ BALL JOINT UPPER CONTROL ARM

(2007-2015 MODELS)

FTS26035 - w/ REAR PERFORMANCE SHOCKS (TRD ONLY)

FTS26036 - w/o SHOCKS

(2016-2019 MODELS)

FTS26067 - w/ REAR PERFORMANCE SHOCKS (TRD ONLY)

FTS26069 - w/o SHOCKS

Fabtech Motorsports | 4331 Eucalyptus Ave. Chino, CA 91710

Tech Line: 909-597-7800 | Fax: 909-597-7185 | Web: www.fabtechmotorsports.com

2007- 2015 MODELS

| FTS26035 COMP BOX W/ PERFORMANCE SHOCKS | | |
|--|-----------|------------------------------|
| 4 | FT1500U | U-BOLT SQ 9/16-18X10.00X2.63 |
| 2 | FT20538 | HIGH TRAVEL BALL JOINT |
| 2 | FT70170BK | SHOCK SPACER |
| 1 | FT70172BK | BALL JOINT UCA (DRIVER) |
| 1 | FT70173BK | BALL JOINT UCA (PASSENGER) |
| 1 | FT70175 | HARDWARE KIT |
| 1 | FT70195 | HARDWARE SUBASSEMBLY |
| 2 | FTBK12 | 1" BLOCK 9/16" PIN |
| 1 | FTS70168D | SPINDLE MACHINED (DRIVER) |
| 1 | FTS70168P | SPINDLE MACHINED (PASSENGER) |
| 2 | FTS7188 | PERFORMANCE SHOCK |

| FTS26036 COMP BOX W/O SHOCKS | | |
|-------------------------------------|-----------|------------------------------|
| 4 | FT1500U | U-BOLT SQ 9/16-18X10.00X2.63 |
| 2 | FT20538 | HIGH TRAVEL BALL JOINT |
| 1 | FT70172BK | BALL JOINT UCA (DRIVER) |
| 1 | FT70173BK | BALL JOINT UCA (PASSENGER) |
| 1 | FT70175 | HARDWARE KIT |
| 1 | FT70195 | HARDWARE SUBASSEMBLY |
| 2 | FTBK12 | 1" BLOCK 9/16" PIN |
| 1 | FTS70168D | SPINDLE MACHINED (DRIVER) |
| 1 | FTS70168P | SPINDLE MACHINED (PASSENGER) |

| FT70195 HARDWARE SUBASSEMBLY | | |
|-------------------------------------|-----------|------------------------------|
| 4 | FT1037 | BUSHING |
| 4 | FT1038 | BUSHING |
| 4 | FT196 | SLEEVE |
| 2 | FT26035I | INSTRUCTIONS |
| 8 | FT57-1 | WASHER 2.188 X .656 X .188 |
| 1 | FT70111 | BRAKE HOSE MOUNT (DRIVER) |
| 1 | FT70112 | BRAKE HOSE MOUNT (PASSENGER) |
| 2 | FT70171 | FRONT DIFF SPACER |
| 4 | FT70174 | BUMP STOP SPACER |
| 2 | FT70196 | BODY MOUNT GUSSET |
| 1 | FT916H | 9/16" U-BOLT HARDWARE KIT |
| 1 | FTAS16 | DRIVER WARNING DECAL |
| 1 | FTLUBE | URETHANE LUBE 1 PACKET |
| 1 | FTREGCARD | REGISTRATION CARD |

| FT70175 - HARDWARE KIT | | LOCATION |
|-------------------------------|--------------------------------|------------------------|
| 2 | 1/2-13 X 6 HEX BOLT G8 ZINC | Diff |
| 2 | 1/2-13 C-LOCK NUT ZINC | |
| 4 | 1/2 SAE WASHER G8 ZINC | |
| 4 | 1/4-20 X 3/4 HEX BOLT G8 ZINC | Brake Line Mount |
| 4 | 1/4 SAE WASHER G8 ZINC | |
| 4 | 1/4 LOCK WASHER ZINC | |
| 2 | 1/4-20 X 1/2 HEX BOLT G8 ZINC | Brake Line Clamp |
| 2 | 1/4 SAE WASHER G8 ZINC | |
| 2 | 1/4 LOCK WASHER ZINC | |
| 8 | 3/8-16 C-LOCK NUT ZINC | Coilover Shock |
| 8 | 3/8 SAE WASHER G5 ZINC | |
| 4 | CLAMP 3/8X1/2W .26THK NEOPRENE | Wheelspeed sensor wire |
| 1 | THREAD LOCKING COMPOUND 1 MIL | |
| 4 | GREASE FITTING 1/4-28 | |
| 2 | ZIP TIE 8" BLACK 40 LBS | |

2016-2019 MODELS

| FTS26067 COMP BOX W/ PERFORMANCE SHOCK | | |
|---|-----------|------------------------------|
| 4 | FT1500U | U-BOLT SQ 9/16-18X10.00X2.63 |
| 2 | FT20538 | HIGH TRAVEL BALL JOINT |
| 2 | FT70170BK | SHOCK SPACER |
| 1 | FT70175 | HARDWARE KIT |
| 1 | FT70195 | HARDWARE SUBASSEMBLY |
| 1 | FT70222BK | BALL JOINT UCA (DRIVER) |
| 1 | FT70223BK | BALL JOINT UCA (PASSENGER) |
| 1 | FT70225D | SPINDLE MACHINED (DRIVER) |
| 1 | FT70225P | SPINDLE MACHINED (PASSENGER) |
| 2 | FTBK12 | 1" BLOCK 9/16" PIN |
| 2 | FTS7188 | PERFORMANCE SHOCK |

| FTS26069 COMP BOX W/O SHOCKS | | |
|-------------------------------------|-----------|------------------------------|
| 4 | FT1500U | U-BOLT SQ 9/16-18X10.00X2.63 |
| 2 | FT20538 | HIGH TRAVEL BALL JOINT |
| 1 | FT70175 | HARDWARE KIT |
| 1 | FT70195 | HARDWARE SUBASSEMBLY |
| 1 | FT70222BK | BALL JOINT UCA (DRIVER) |
| 1 | FT70223BK | BALL JOINT UCA (PASSENGER) |
| 1 | FT70225D | SPINDLE MACHINED (DRIVER) |
| 1 | FT70225P | SPINDLE MACHINED (PASSENGER) |
| 2 | FTBK12 | 1" BLOCK 9/16" PIN |

| FT70195 HARDWARE SUBASSEMBLY | | |
|-------------------------------------|-----------|------------------------------|
| 4 | FT1037 | BUSHING |
| 4 | FT1038 | BUSHING |
| 4 | FT196 | SLEEVE |
| 2 | FT26035I | INSTRUCTIONS |
| 8 | FT57-1 | WASHER 2.188 X .656 X .188 |
| 1 | FT70111 | BRAKE HOSE MOUNT (DRIVER) |
| 1 | FT70112 | BRAKE HOSE MOUNT (PASSENGER) |
| 2 | FT70171 | FRONT DIFF SPACER |
| 4 | FT70174 | BUMP STOP SPACER |
| 2 | FT70196 | BODY MOUNT GUSSET |
| 1 | FT916H | 9/16" U-BOLT HARDWARE KIT |
| 1 | FTAS16 | DRIVER WARNING DECAL |
| 1 | FTLUBE | URETHANE LUBE 1 PACKET |
| 1 | FTREGCARD | REGISTRATION CARD |

| FT70175 - HARDWARE KIT | | LOCATION |
|-------------------------------|--------------------------------|------------------------|
| 2 | 1/2-13 X 6 HEX BOLT G8 ZINC | Diff |
| 2 | 1/2-13 C-LOCK NUT ZINC | |
| 4 | 1/2 SAE WASHER G8 ZINC | |
| 4 | 1/4-20 X 3/4 HEX BOLT G8 ZINC | Brake Line Mount |
| 4 | 1/4 SAE WASHER G8 ZINC | |
| 4 | 1/4 LOCK WASHER ZINC | |
| 2 | 1/4-20 X 1/2 HEX BOLT G8 ZINC | Brake Line Clamp |
| 2 | 1/4 SAE WASHER G8 ZINC | |
| 2 | 1/4 LOCK WASHER ZINC | |
| 8 | 3/8-16 C-LOCK NUT ZINC | Coilover Shock |
| 8 | 3/8 SAE WASHER G5 ZINC | |
| 4 | CLAMP 3/8X1/2W .26THK NEOPRENE | Wheelspeed sensor wire |
| 1 | THREAD LOCKING COMPOUND 1 MIL | |
| 4 | GREASE FITTING 1/4-28 | |
| 2 | ZIP TIE 8" BLACK 40 LBS | |

- PRE-INSTALLATION NOTES -

For technical assistance call: **909-597-7800** or e-mail: **info@fabtechmotorsports.com**

Read this before you begin installation-

NOTE: THE INSTALLATION OF THIS KIT REQUIRES WELDING, AND SHOULD BE PERFORMED BY A CERTIFIED WELDER

Check all parts to the parts list above before beginning installation. If any parts are missing contact Fabtech at 909-597-7800 and a replacement part will be sent to you immediately.

Read all instructions thoroughly from start to finish before beginning the installation. If these instructions are not properly followed severe frame, driveline and / or suspension damage may occur.

Check your local city and state laws prior to the installation of this system for legality. Do not install if not legal in your area.

Prior to the installation of this suspension system perform a front end alignment and record. Do not install this system if the vehicle alignment is not within factory specifications. Check for frame and suspension damage prior to installation.

The installation of this suspension system should be performed by two professional mechanics.

Installation of all fasteners requires the use of provided thread locking compound with proper torque values as indicated throughout the installation. Apply thread locking compound upon the final torque of the fastener.

WARNING- Installation of this system will alter the center of gravity of the vehicle and may increase roll over as compared to stock.

Vehicles that receive oversized tires should check ball joints, uniballs, tie rods ends, pitman arm and idler arm every 2500-5000 miles for wear and replace as needed.

Verify differential fluid is at manufactures recommended level prior to kit installation. Installation of the kit will reposition the differential and the fill plug hole may be in a different position. (For example, if the manufacture recommends 3 quarts of fluid, make sure the diff has 3 quarts of fluid). Check your specific manual for correct amount of fluid.

NOTE: BASIC NON-COILOVER KIT WILL NOT FIT NON TRD OR TRD PRO MODELS.

FOOTNOTES-

- Will not work with 17" wheels.
- Cannot use OEM wheel and tire.
- Fits TRD models only.
- Will not work on TRD PRO models

- TOOL LIST -

Required Tools (Not Included)

Basic Hand Tools
Floor Jack
Jack Stands
Assorted Metric and S.A.E sockets, and Allen wrenches
Torque Wrench
Die Grinder

- INSTRUCTIONS -

FRONT SUSPENSION

1. Disconnect the negative terminal on the battery. Jack up the front end of the truck and support the frame rails with jack stands. **NEVER WORK UNDER AN UNSUPPORTED VEHICLE!** Remove the front tires.
2. Working from front of the truck, locate and remove the factory skid plate. Discard skid plate and hardware, these will not be reinstalled on the truck. **SEE FIGURES 1-2**



3. Remove factory mud flaps off front of the vehicle and discard. **SEE FIGURES 3-4**



4. Remove the sway bar link ends from the lower control arm.
5. Starting on the driver's side, disconnect the tie rod end from the steering knuckle by striking the knuckle to dislodge the tie rod end. Use care not to damage the ball joints.

6. Remove the brake hose bracket from the top of the steering knuckle. Remove the caliper from the rotor and place above the upper control arm during this portion of the installation. Remove brake rotor from the steering knuckle. Unbolt the wheel speed sensor connection from the hub and control arm. **SEE FIGURES 5-7**

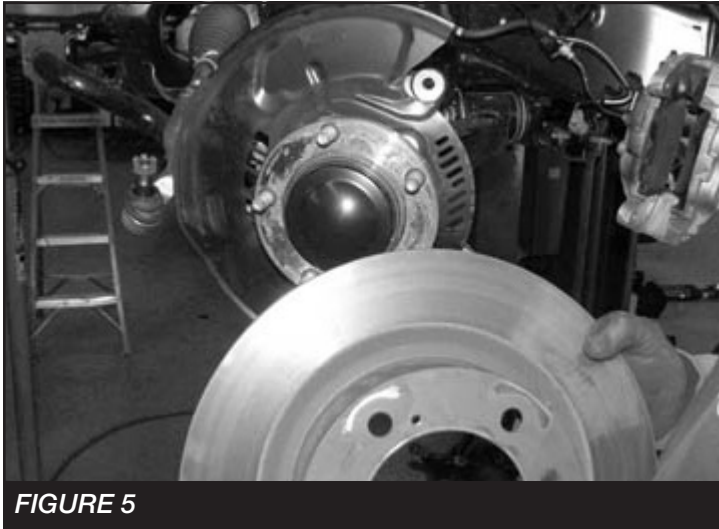

FIGURE 5

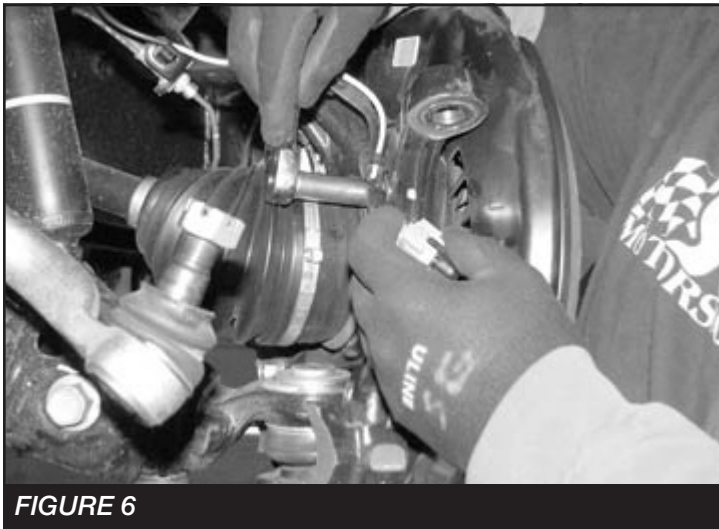

FIGURE 6

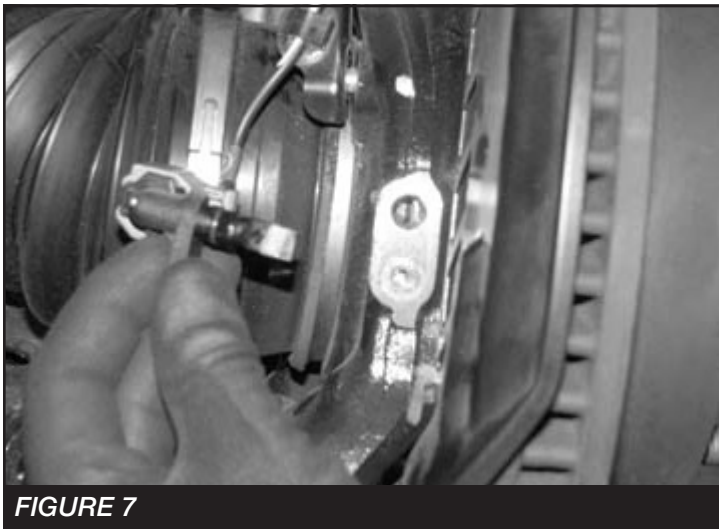

FIGURE 7

7. Remove axle nut, washer and the 4 hub bolts on backside of knuckle. Remove bearing hub assembly from knuckle. Retain parts and hardware for reinstallation.

SEE FIGURES 8-9

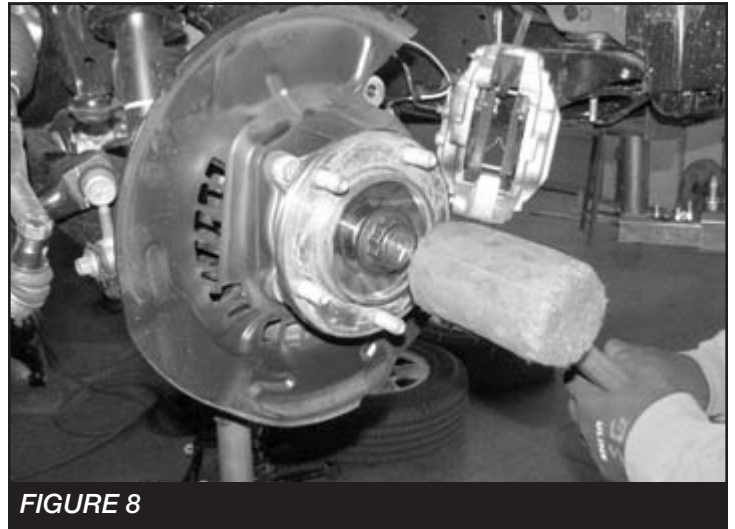

FIGURE 8

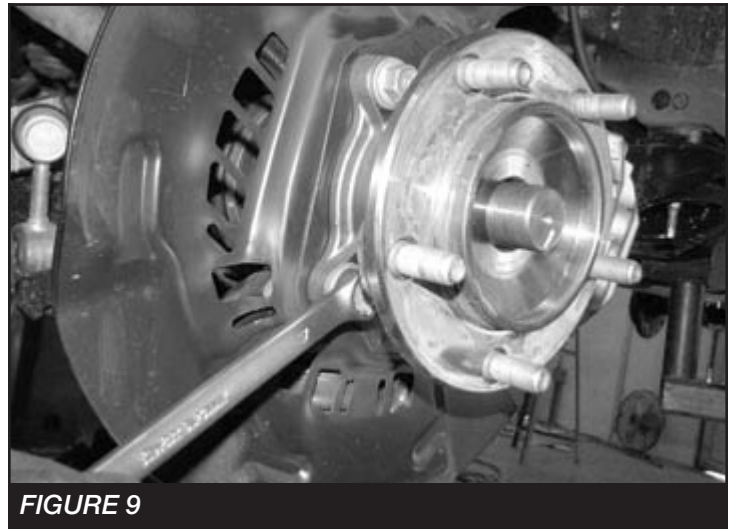

FIGURE 9

8. Remove the upper ball joint nuts. Disconnect the upper ball joints from the steering knuckle by striking the knuckle with a large hammer next to the ball joint on the knuckle to dislodge the ball joints. Use care not to hit the ball joints when removing. Retain nuts. **SEE FIGURE 10**

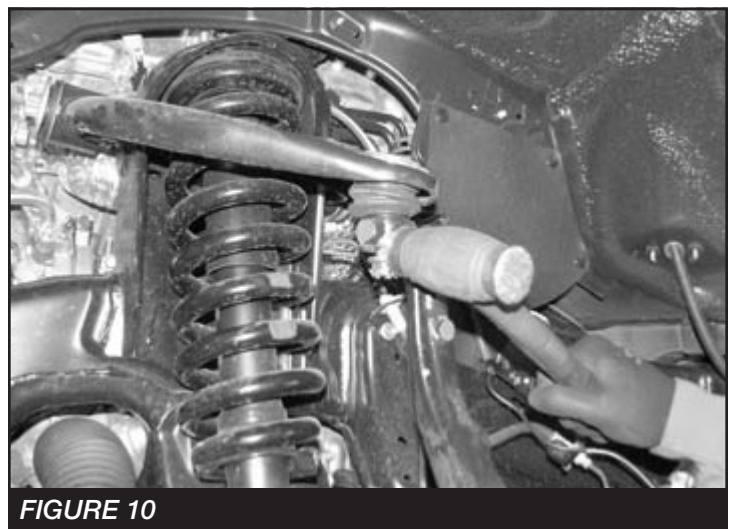

FIGURE 10

9. Loosen the castle nut on the lower ball joint and strike the lower ball joint boss assembly with a large hammer next to the ball joint to dislodge (use care not to hit the ball joint when removing). Remove the two bolts on each side connecting the lower ball joint assembly to the knuckle and remove the knuckle. Remove the castle nut from the lower ball joint and remove the boss from the ball joint. Save the castle nut and discard the knuckle.

SEE FIGURES 11-13

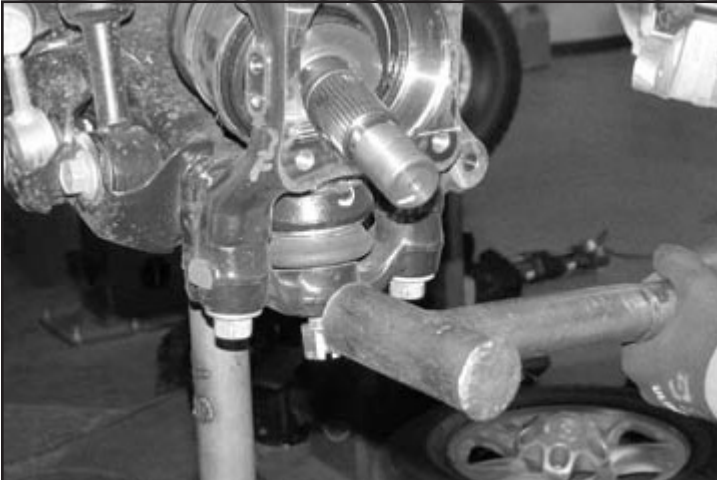

FIGURE 11

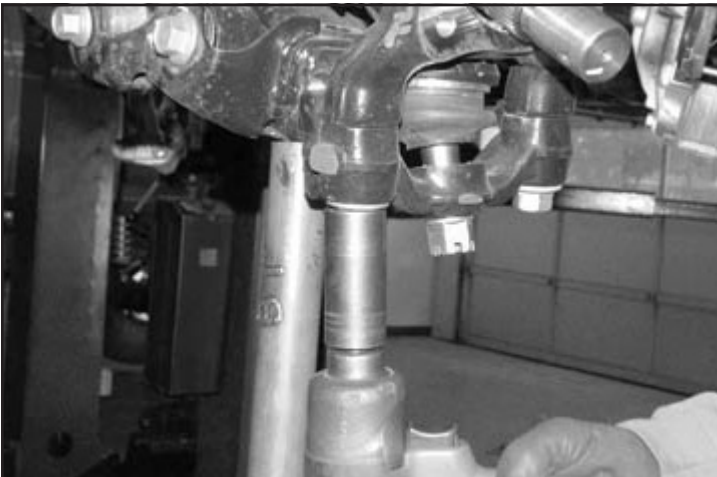

FIGURE 12



FIGURE 13

10. Remove the factory coil over shock. Save the factory shock and hardware if not installing Dirt Logic shock.

SEE FIGURES 14-15

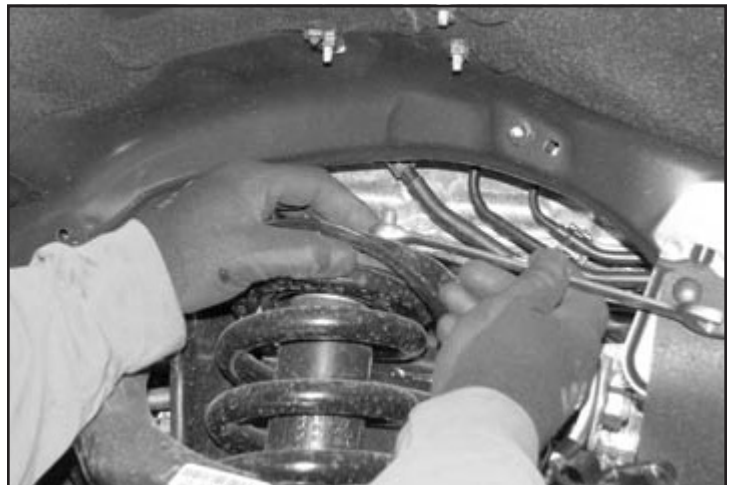

FIGURE 14

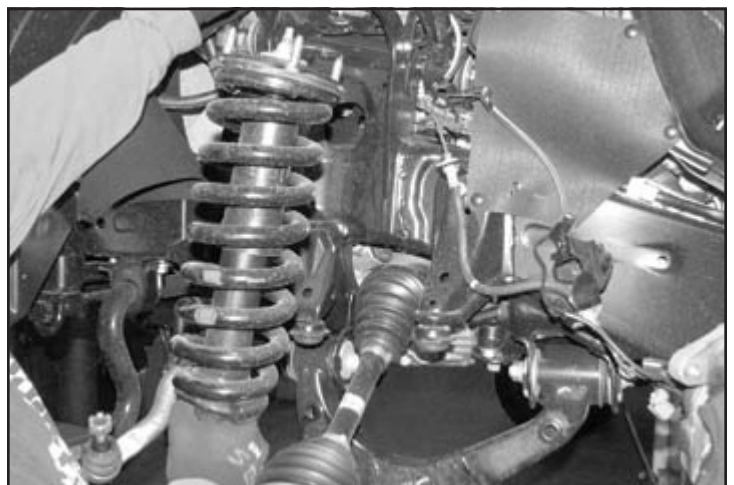

FIGURE 15

11. Support the front differential with a transmission or floor jack. Remove the front passenger and driver diff bolts.

SEE FIGURE 16



FIGURE 16

12. Locate two of the FT70171 front diff spacer and two ½" -13 x 6" bolts nuts and washers. Install the Diff spacers under the factory mounts. Torque to 90 ft-lbs.

SEE FIGURES 17-19

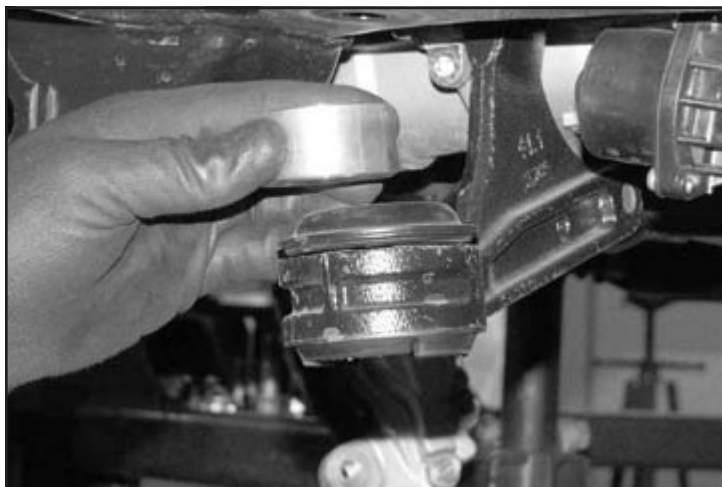

FIGURE 17

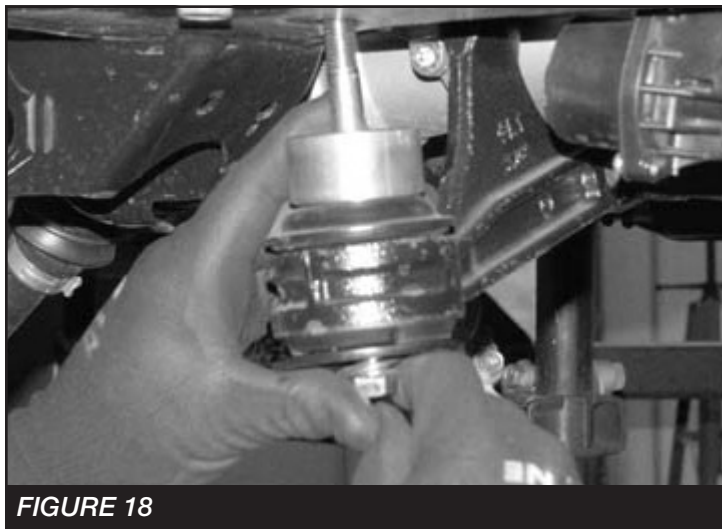

FIGURE 18

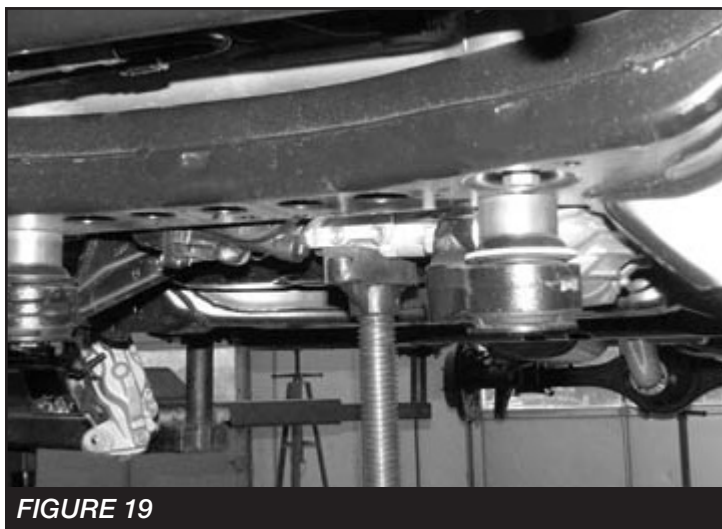

FIGURE 19

13. Locate the four factory compression bump stops and remove and save. **SEE FIGURE 20**

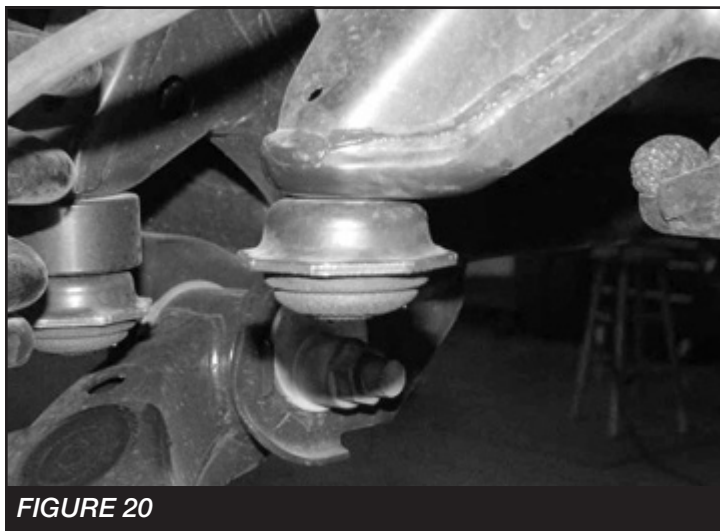

FIGURE 20

14. Using a die grinder remove a ¼" of thread from the threaded portion of the bump stop. **SEE FIGURES 21-22**



FIGURE 21



FIGURE 22

15. Locate the four FT70174 bump stop spacers and thread in to the factory bump stop mounts. **SEE FIGURE 23**

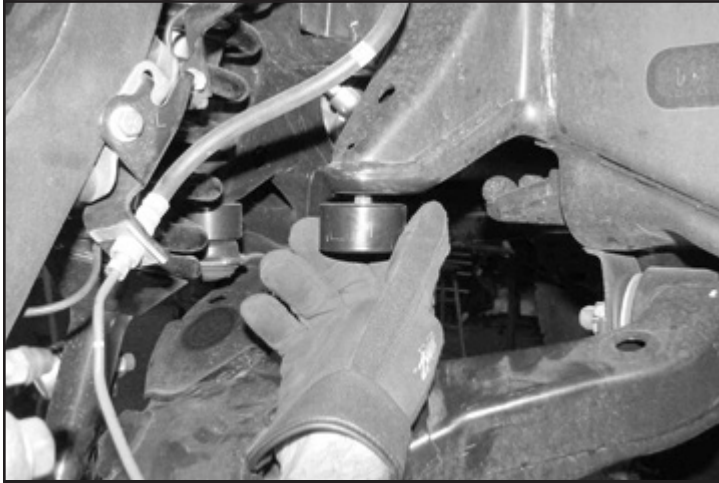

FIGURE 23

16. Thread the cut bump stop into the new spacer. Torque to 17 ft-lbs.

17. Remove the upper control arm. Retain the factory hardware. **SEE FIGURES 24-25**



FIGURE 24



FIGURE 25

18. Locate the Fabtech driver's side control arm FT70172BK or FT70222BK, Two FT1038, two 1037 bushings two grease zerks FT84, two FT196 sleeves and the ball joint FT20538.

19. Install all these components in the control arm barrels. Install the ball joint onto the bottom side of the control arm ball joint plate. Use the supplied 5/16" bolts, nuts and washers. Torque to 29 ft-lbs. **SEE FIGURES 26-30**

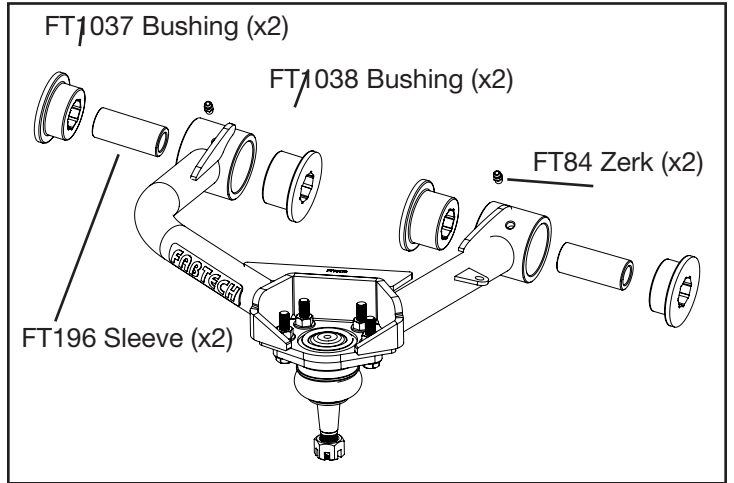

FIGURE 26



FIGURE 27

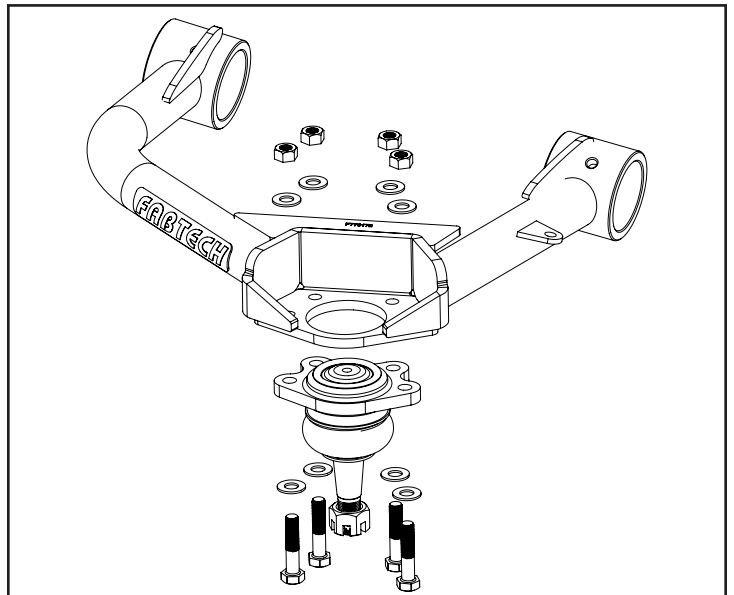

FIGURE 28

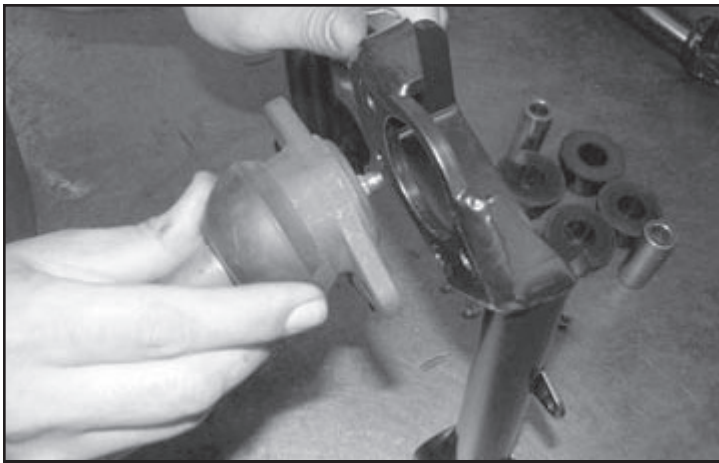

FIGURE 29

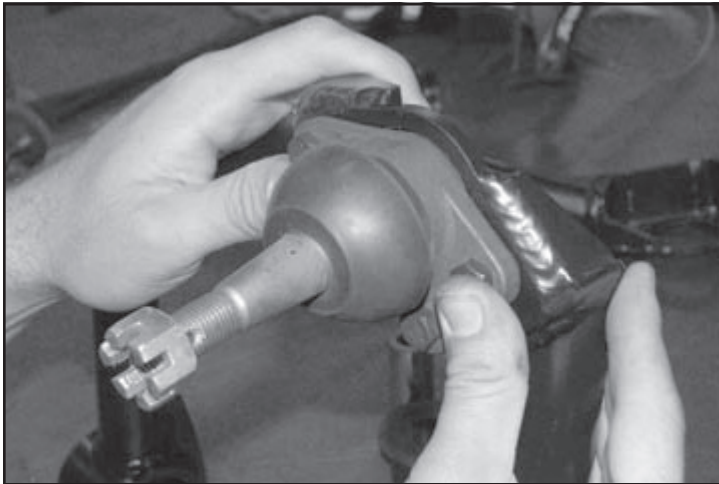

FIGURE 30

20. Install the upper arm using the factory hardware. Place the new FT57-1 washers on the inside and outside of the bushings. When installing the arm on the truck make sure the barrel gussets are up. Torque to 200 ft-lbs.

SEE FIGURES 31-32

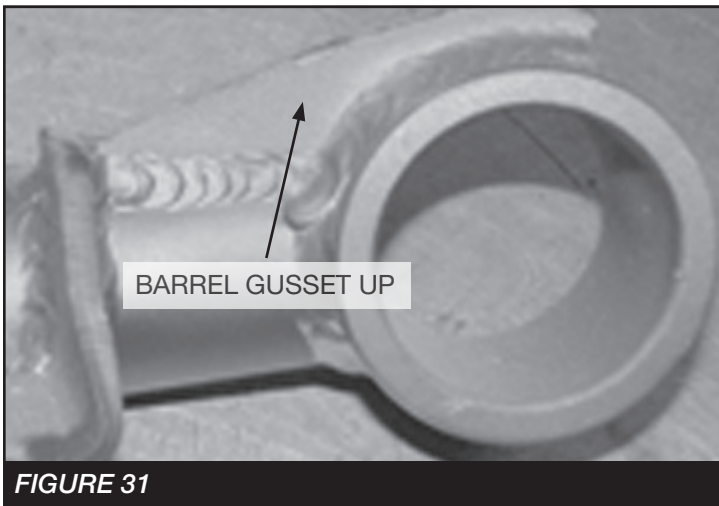

FIGURE 31

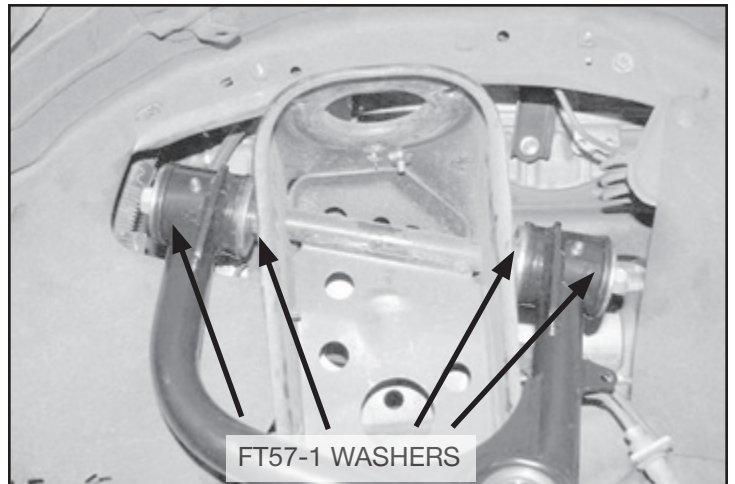

FIGURE 32

21. Locate the factory lower control arm shock mount. The inside gusset plate will need to be cut back to allow for the extra shock clearance. Use a 1.5 "barrel sander and cut back 3/8" in to the shock mount towards the center of the vehicle. **SEE FIGURES 33-34**

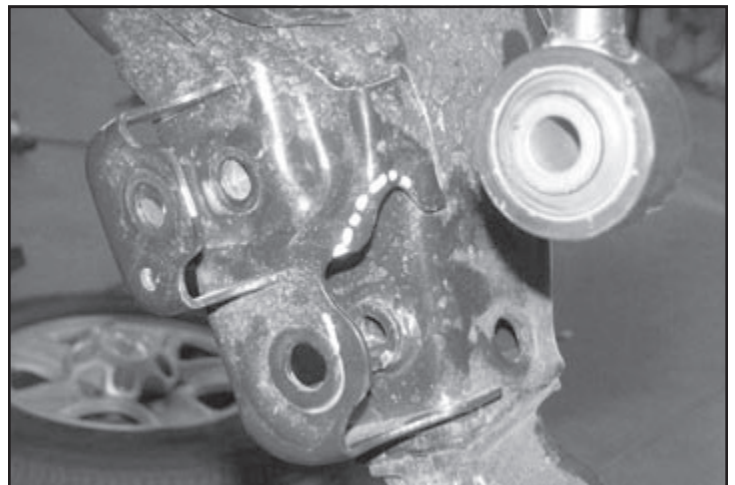

FIGURE 33



FIGURE 34

If installing Dirt Logic shock, skip steps 22-23 and refer to the instructions provided with the Dirt Logic shock.

22. Locate the FT70170BK shock spacer and install it onto the top of the factory coil over using the factory hardware and torque 35 ft-lbs. **SEE FIGURES 35-36**



FIGURE 35

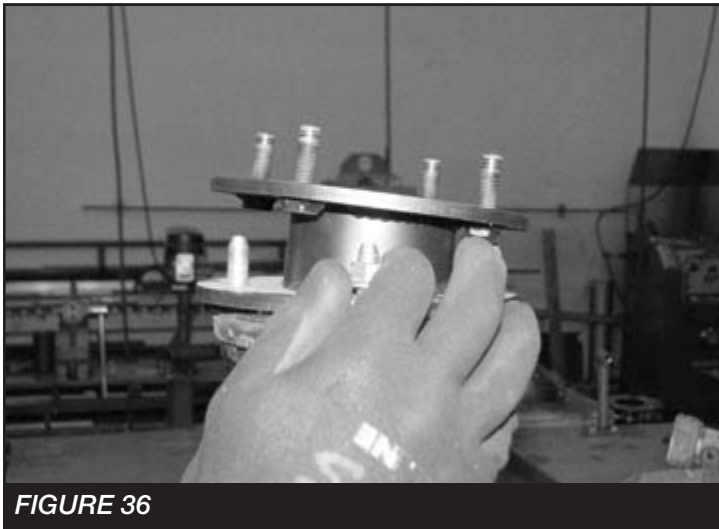

FIGURE 36

23. Install the coil over into the upper shock mount using four 3/8" washers and nuts. Install the lower factory rod end into the lower control mount using factory hardware. Torque the upper bolts to 37 ft-lbs and the lower 160 ft-lbs. **SEE FIGURES 37-39**

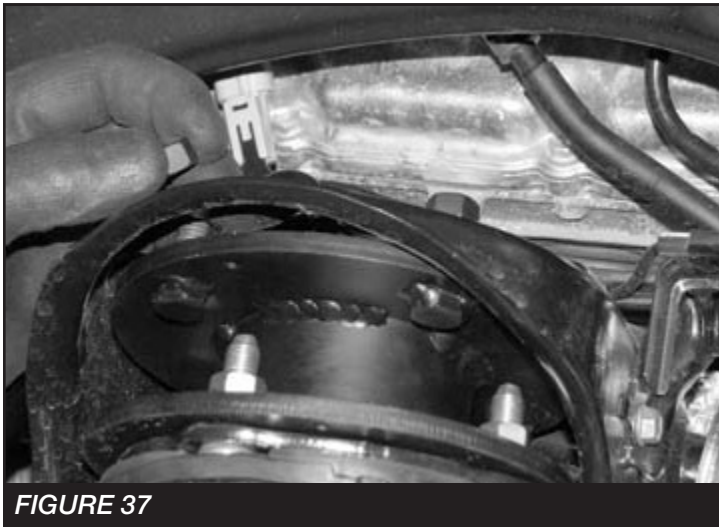

FIGURE 37



FIGURE 38

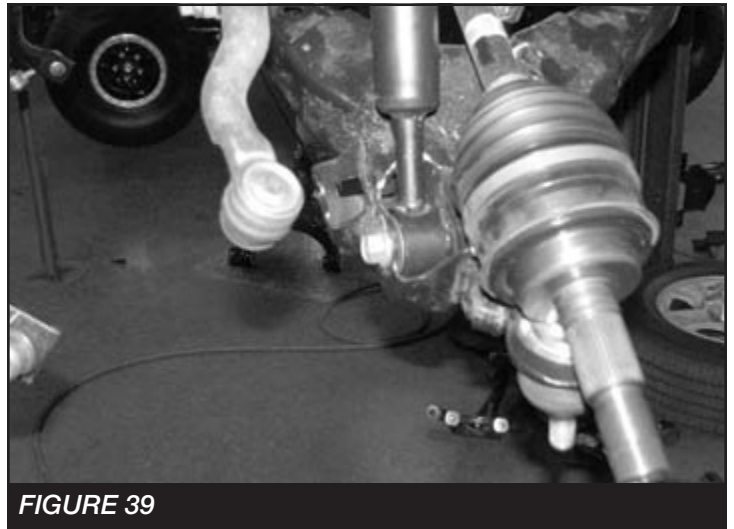

FIGURE 39

24. Locate the factory steering knuckles and remove inner seal.
25. Locate the new Fabtech FTS70168D or FT70225D steering knuckle. Install the factory inner seal. **NOTE:** 2wd models have a dust shield that must be taken out of the stock knuckle and installed in the new Fabtech knuckle. **SEE FIGURE 40-44**



FIGURE 40



FIGURE 41



FIGURE 42



FIGURE 43



FIGURE 44

26. Position the knuckle onto the lower ball joint and CV Axle (4wd only) at the same time and install the lower ball joint nut. Leave loose (make sure not to damage the CV & CV Boot or the seal in the knuckle). Then attach top of the knuckle to the upper ball joint with the nut. Torque the upper ball joint nut to 81 ft-lbs and the lower ball joint nut to 123 ft-lbs. **SEE FIGURES 45-46**



FIGURE 45

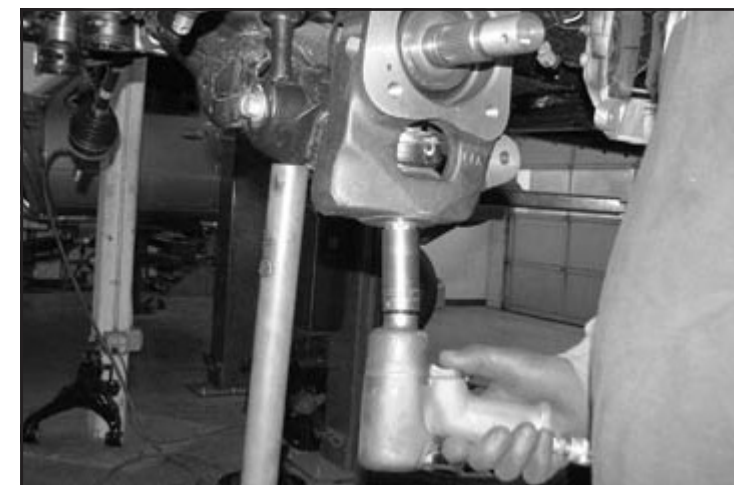

FIGURE 46

27. Install the factory hubs, backing plates, and the dust covers with the factory hardware and supplied thread-locking compound. **NOTE: Trimming the dust shield may be required to properly installed the brake caliper.** Torque the hub bolts to 73 ft-lbs. Torque the CV Axle nut to 249 ft-lbs. & install axle nut retainer with new supplied cotter pin. **SEE FIGURE 47-49**

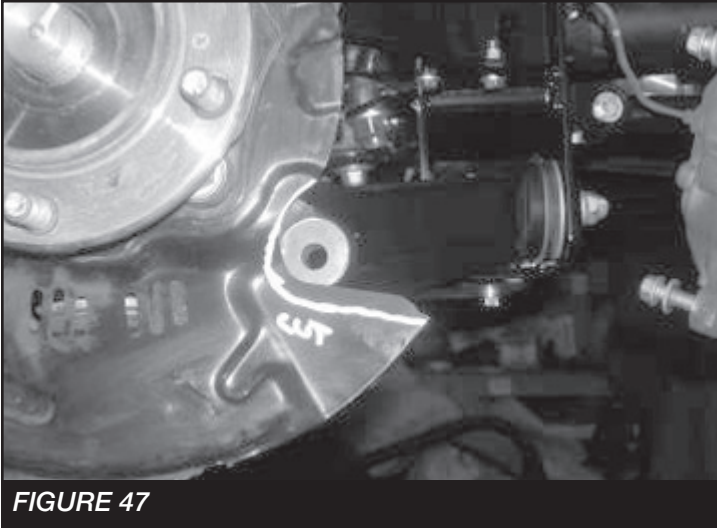

FIGURE 47

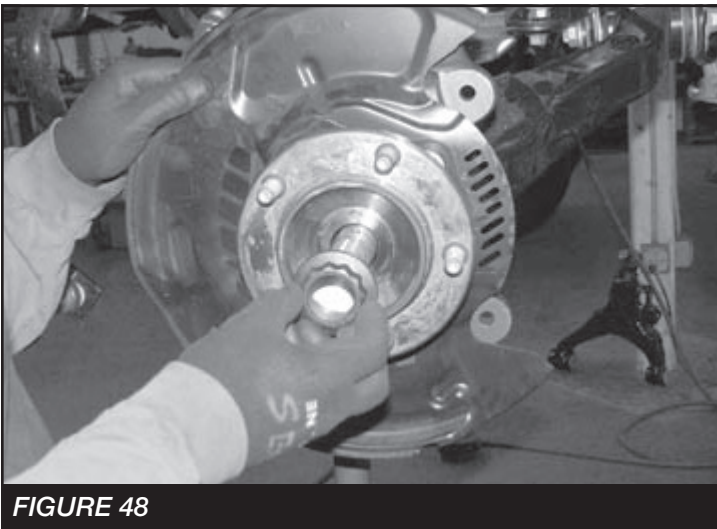

FIGURE 48

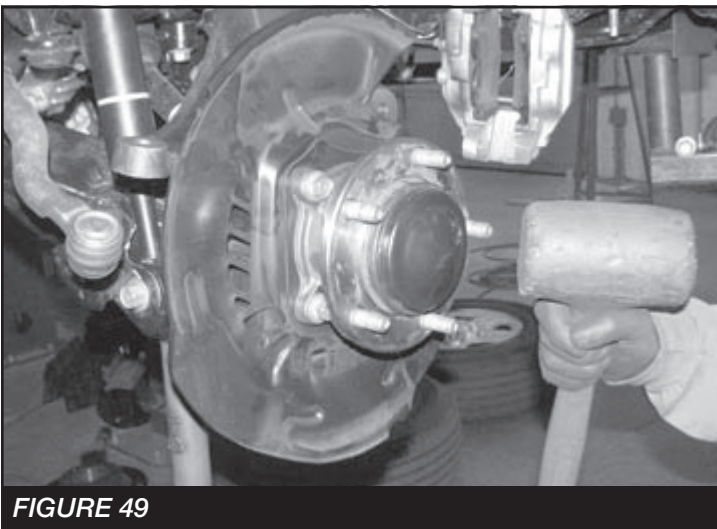

FIGURE 49

28. Reinstall the lower sway bar link to the lower control arm. Torque to 100 ft-lbs. **SEE FIGURE 50**

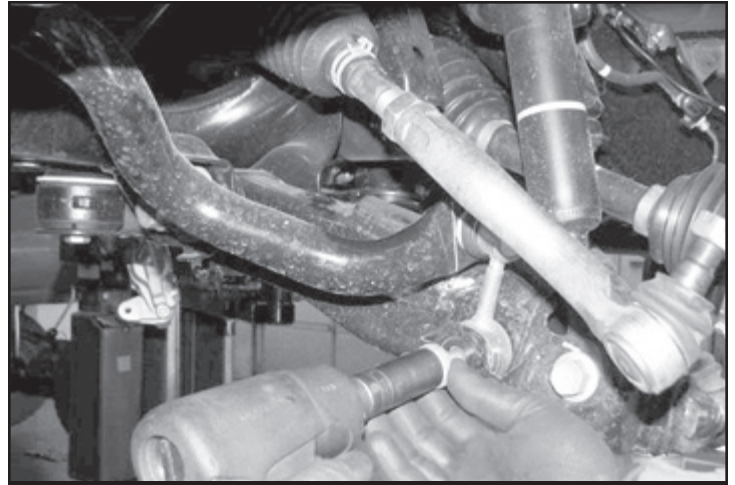

FIGURE 50

29. Install brake rotors & brake calipers with the factory hardware and thread locking compound. Torque the caliper bolts to 73 ft-lbs. Locate FT70111 (dry) Brake Hose Mount Bracket and the supplied $\frac{1}{4}$ " x $\frac{3}{4}$ " hardware. Mount the bracket to the knuckle. Mount the factory brake hose to the new bracket with the $\frac{1}{4}$ " x $\frac{1}{2}$ " hardware. Torque to 10 ft-lbs. Remove the factory tie rod end. Using a die grinder cut $\frac{3}{8}$ " off the tie rod, and reinstall the tie rod end. **SEE FIGURES 51-52**

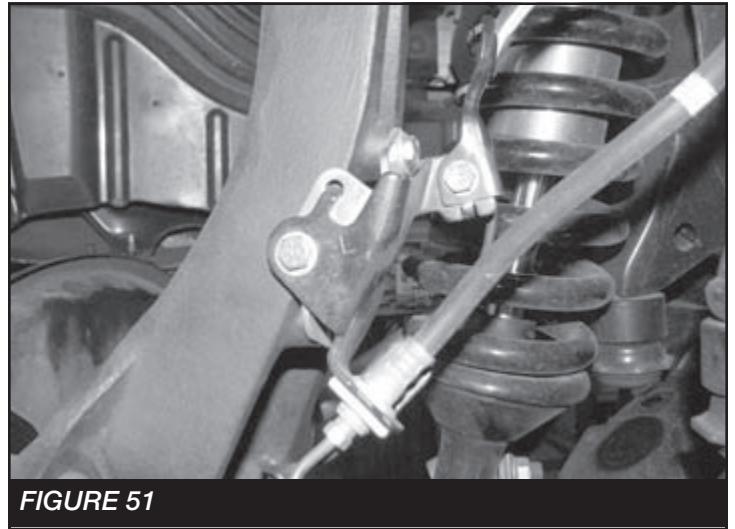

FIGURE 51

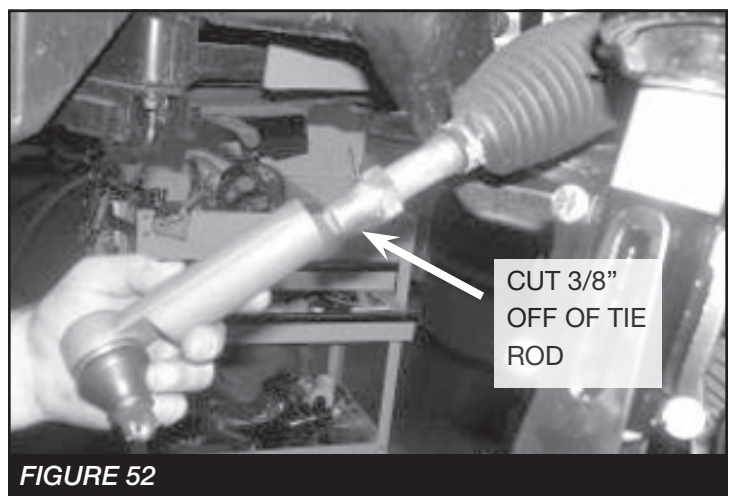
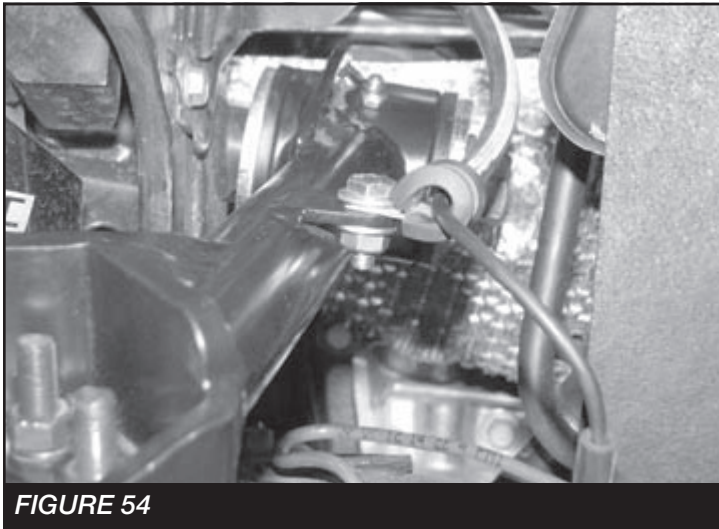
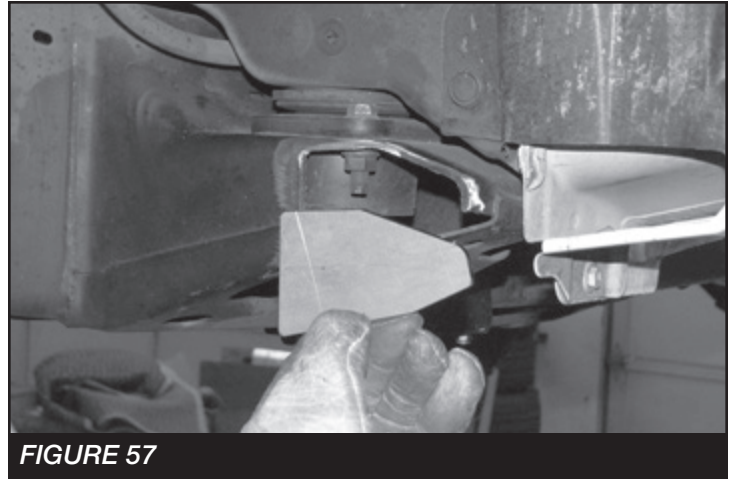
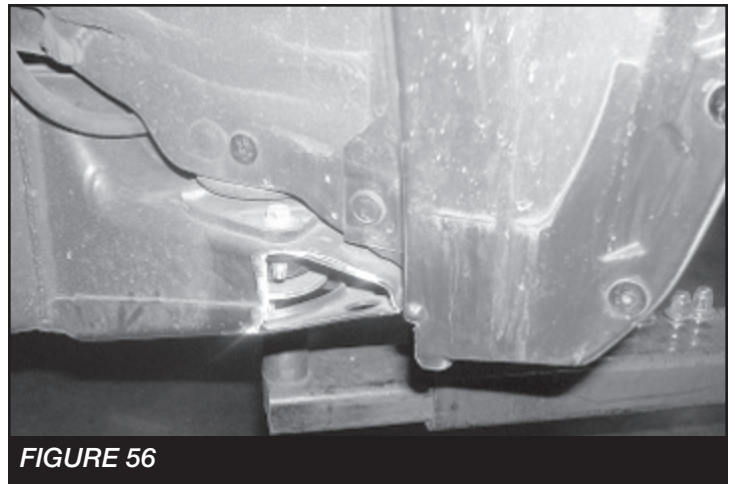
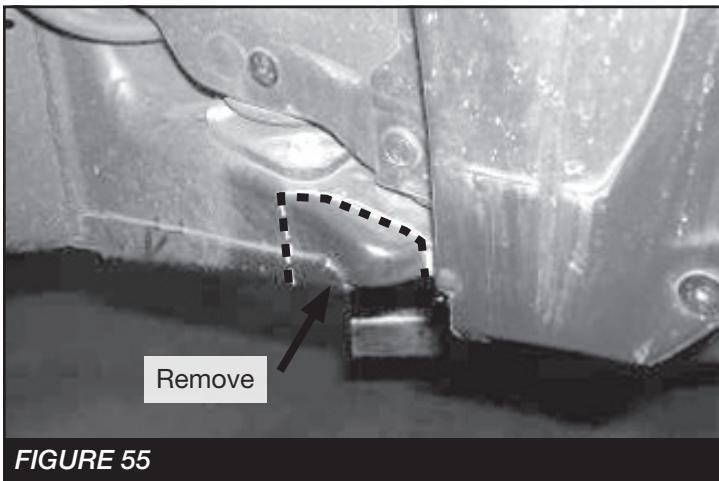

FIGURE 52

30. Locate the FTclamp , ¼ -20 x ½ bolt , nut and washer. Attach the wheel speed sensor to the tab on the upper control arm with the clamp and hardware. Torque to 10 ft-lbs. **SEE FIGURES 53-54**



31. Repeat 5 – 30 on the passenger side.
32. Locate the factory body mount in the back of the wheel well. Mark and cut as shown in photos. Locate FT70196 gusset and weld on as shown. Sand and paint all cut areas. **SEE FIGURES 55-59**



REAR SUSPENSION

33. Locate and install the rear lift blocks FTBK12 to the axle. Using the provided U bolts FT1500U, nuts and washers, align axle, lift blocks, and springs and torque U-bolts to 130 ft-lbs. **SEE FIGURES 60-62**

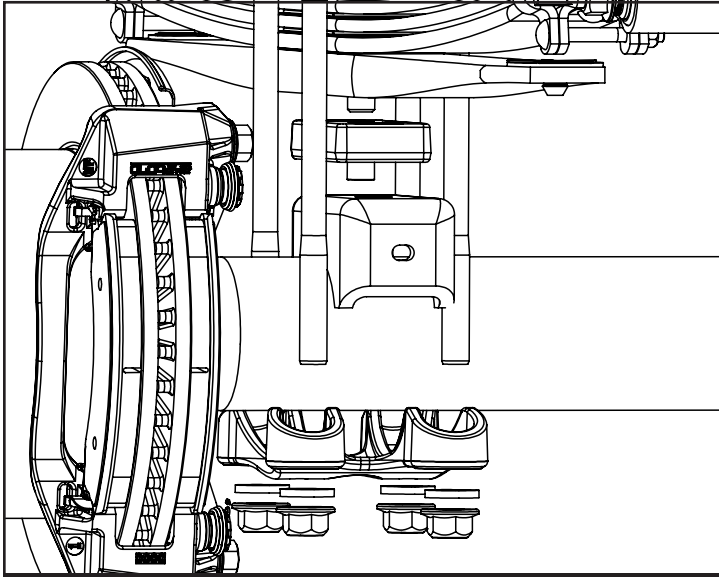

FIGURE 60

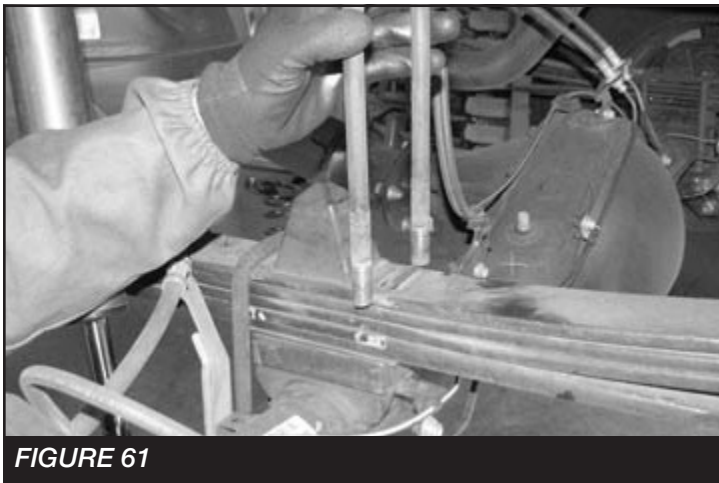

FIGURE 61

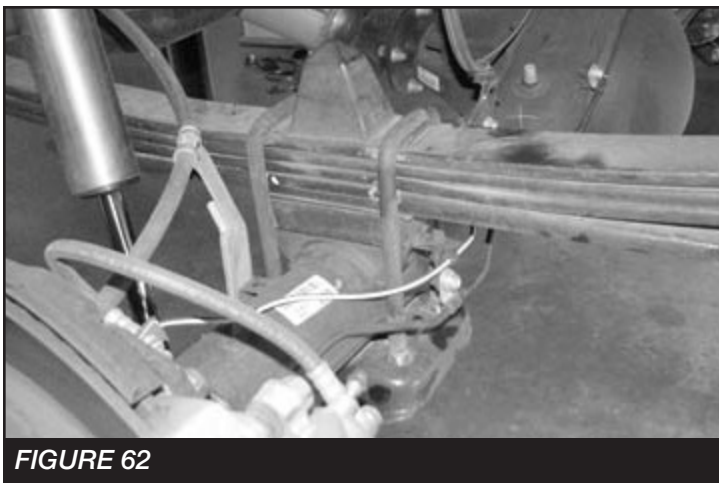

FIGURE 62

34. Install rear Performance shock (FTS7188) using the factory hardware.
35. Install tires and wheels and torque lug nuts to wheel manufacturer's specifications. Turn front tires left to right and check for appropriate tire clearance. **Note - Some oversized tires may require trimming of the front bumper & valance.**
36. Check front end alignment and set to factory specifications. Readjust headlights.
37. Recheck all bolts for proper torque.
38. Recheck brake hoses, ABS wires and suspension parts for proper tire clearance while turning tires fully left to right.
39. Check the fluid in the front and rear differential and fill if needed with factory specification differential oil. **Note - some differentials may expel fluid after filling and driving. This can be normal in resetting the fluid level with the new position of the differential/s.**
40. Install Driver Warning Decal. Complete product registration card and mail to Fabtech in order to receive future safety and technical bulletins on this suspension.
41. Have vehicle properly aligned to factory specs.

Vehicles that will receive oversized tires should check ball joints, uniballs and all steering components every 2500-5000 miles for wear and replace as required.

RE-TORQUE ALL NUTS, BOLTS AND LUGS AFTER 50 MILES AND PERIODICALLY THEREAFTER.

For technical assistance call: **909-597-7800**

- Product Warranty and Warnings -

Fabtech provides a Limited Lifetime Warranty to the original retail purchaser who owns the vehicle, on which the product was originally installed, for defects in workmanship and materials.

The Limited Lifetime Warranty excludes the following Fabtech items; bushings, bump stops, ball joints, tie rod ends, limiting straps, cross shafts, heim joints and driveshafts. These parts are subject to wear and are not considered defective when worn. They are warranted for 60 days from the date of purchase for defects in workmanship.

Dirt Logic and Performance Coilover take apart shocks are considered a serviceable shock with a one year warranty on leakage only. Service seal kits are available separately for future maintenance. All other shocks are covered under our Limited Lifetime Warranty.

Fabtech does not warrant any product for finish, alterations, modifications and/or installation contrary to Fabtech's instructions. Alterations to the finish of the parts including but not limited to painting, powder coating, plating and/or welding will void all warranties. Some finish damage may occur to parts during shipping, which is considered normal and is not covered under warranty.

Fabtech products are not designed nor intended to be installed on vehicles used in race applications or for racing purposes or for similar activities. (A "RACE" is defined as any contest between two or more vehicles, or any contest of one or more vehicle against the clock, whether or not such contest is for a prize). This warranty does not include coverage for police or taxi vehicles, race vehicles, or vehicles used for government or commercial purposes. Also excluded from this warranty are sales outside of the United States of America.

Installation of most suspension products will raise the center of gravity of the vehicle and will cause the vehicle to handle differently than stock. It may increase the vehicle's susceptibility to a rollover, on road and off road, at all speeds. Extreme care should be taken to operate the vehicle safely at all times to prevent rollover or loss of control resulting in serious injury or death. Fabtech front end Desert Guards may impair the deployment or operation of vehicles equipped with supplemental restraining systems/air bag systems and should not be installed if the vehicle is equipped as so.

Fabtech makes every effort to ensure suspension product compatibility with all vehicles listed on the website, but due to unknown auto manufacturer's production changes and/or inconsistencies by the auto manufacturer, Fabtech cannot be responsible for 100% compatibility, including the fitment of tire and wheel sizes listed. The Tire and Wheel sizes listed in Fabtech's website are only a guideline for street driving with noted fender trimming. Fabtech is not responsible for damages to the vehicle's body or tires. Fabtech is not responsible for premature wear of factory components due to the installation of oversized tires and wheels.

Fabtech's obligation under this warranty is limited to the repair or replacement, at Fabtech option, of the defective product only. All costs of removal, installation or re-installation, freight charges, incidental or consequential damages are expressly excluded from this warranty. Fabtech is not responsible for damages and/or warranty of other vehicle parts related or non related to the installed Fabtech product. This warranty is expressly in lieu of all other warranties expressed or implied. This warranty shall not apply to any product that has been subject to accident, negligence, alteration, abuse or misuse as determined by Fabtech.

Fabtech suspension components must be installed as a complete system including shocks as shown on our website. All warranties will become void if Fabtech parts are combined and/or substituted with other aftermarket suspension products. Combination and/or substitution of other aftermarket suspension parts may cause premature wear and/or product failure resulting in an accident causing injury or death. Fabtech does not warrant products not manufactured by Fabtech.

Depending on the condition of the factory suspension components retained after the installation of a Fabtech suspension not all vehicles may have the same ride stance front to rear as described in the website. The blue color of suspension components shown in all Fabtech photographs are for display purposes only. Majority of all Fabtech components will be black specifically where noted with part numbers ending in BK.

Installation of Fabtech product may void the vehicles factory warranty; it is the consumer's responsibility to check with their local vehicle's dealer for warranty disposition before the installation of the product. Some state laws may prohibit modification of suspension to a vehicle in whole or in part. It is the responsibility of the installer and consumer to consult local laws prior to the installation of any Fabtech suspension product to comply with such written laws.

It is the responsibility of the distributor and/or the retailer to review all warranties and warnings of Fabtech products with the consumer prior to purchase.

Fabtech reserves the right to super cede, discontinue, change the design, finish, part number and/or application of parts when deemed necessary without written notice. Fabtech is not responsible for misprints or typographical errors within the website or price sheet. For the most recent Product Warranty and Warnings visit our website www.fabtechmotorsports.com