

Preparation:

- Disconnect the negative battery terminal. Park the vehicle on level ground and set the emergency brake.
- We recommend reading through the installation instructions in whole before performing the work.
- Estimated Installation Time: **4 Hours**

*****This installation requires 2 people for best results*****

You will need the following tools:

- | | | |
|---------------------------|---------------------------|---------------------------|
| - Ratchet | - 7mm Socket | - 8mm Socket |
| - 10mm Socket | - 11mm Socket | - 13mm Socket |
| - 15mm Socket | - 8mm Wrench | - 13mm Wrench |
| - T27 Torx Bit | - E6 External Torx Socket | - 3mm Allen Wrench/Socket |
| - 5mm Allen Wrench/Socket | - Masking Tape | - Cutoff Wheel |
| - Grinder | | |

Included in Kit:

- | | |
|---|---|
| 2 - Hex Head Bolts (M8-1.25 x 16mm) | 1 - Socket Head Bolt (M4-0.7 x 10mm) |
| 3 - Flat Washers (M8) | 1 - Flat Washer (#6) |
| 1 - Nylon Lock Nuts (M8-1.25) | 1 - Socket Head Bolt (M6-1.0 x 18mm) |
| 6 - Button Head Bolts (3/8"-16 x 3/4") | 6 - Flat Washers (3/8") |
| 6 - Nylon Lock Nuts (3/8"-16) | 1 - Rubber Cap |
| 1 - Zip Tie | 1 - CARB Compliance Sticker |

*****If you are installing this kit in conjunction with one of our bumpers, we recommend removing the OEM bumper, installing this kit, then installing your newly purchased bumper*****

Installation:

1. Using a 13mm and 15mm Socket, remove the skid plate mounting bolts (x6). Then, remove the OEM skid plate. (Fig A)

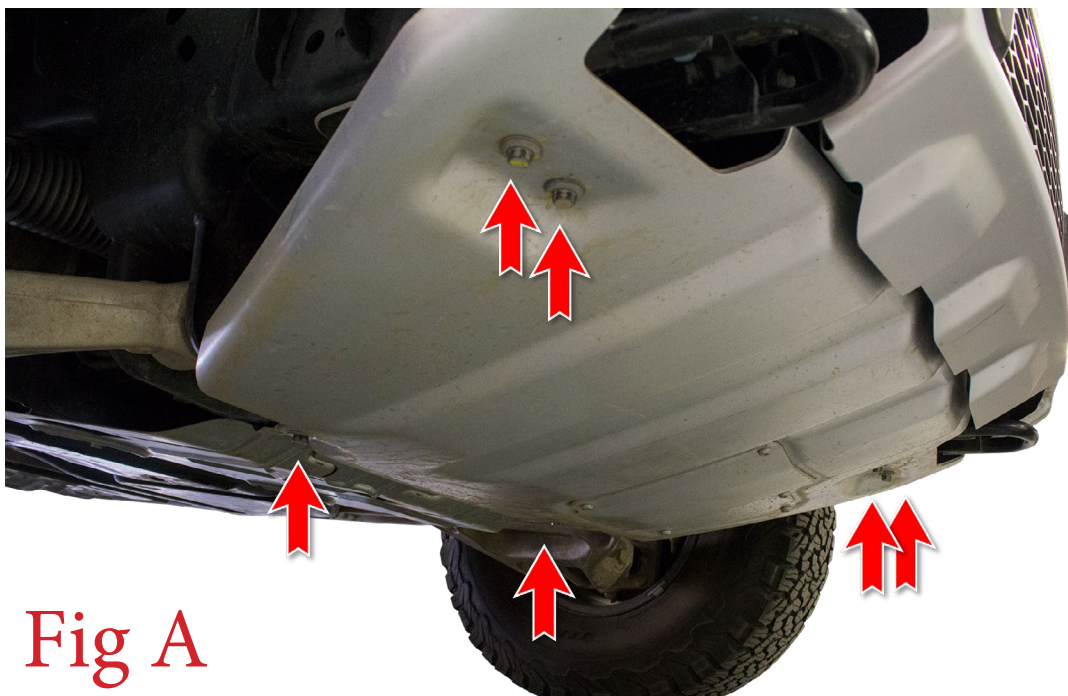

Fig A

2. IF YOU DO NOT PLAN TO RELOCATE YOUR ADAPTIVE CRUISE CONTROL MODULE, PLEASE SKIP THIS STEP. Carefully pull the front plastic piece off your bumper. There are no tools required for this step, it pulls off by hand. (Fig B)



Fig B

3. IF YOU DO NOT PLAN TO RELOCATE YOUR ADAPTIVE CRUISE CONTROL MODULE, PLEASE SKIP THIS STEP. Using an 11mm Socket, remove the three mounting nuts for the Adaptive Cruise Module. Then, use an E6 External Torx Socket to remove the three mounting studs for the module. Unplug and remove the module once the mounting bolts/nuts have been removed. (Fig C)

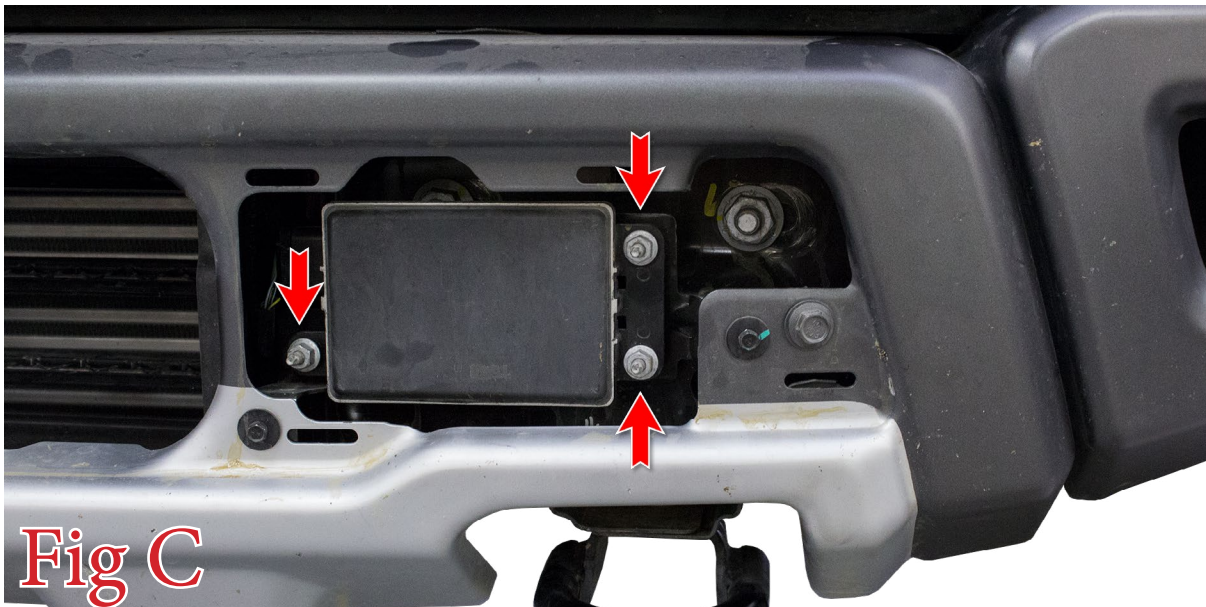
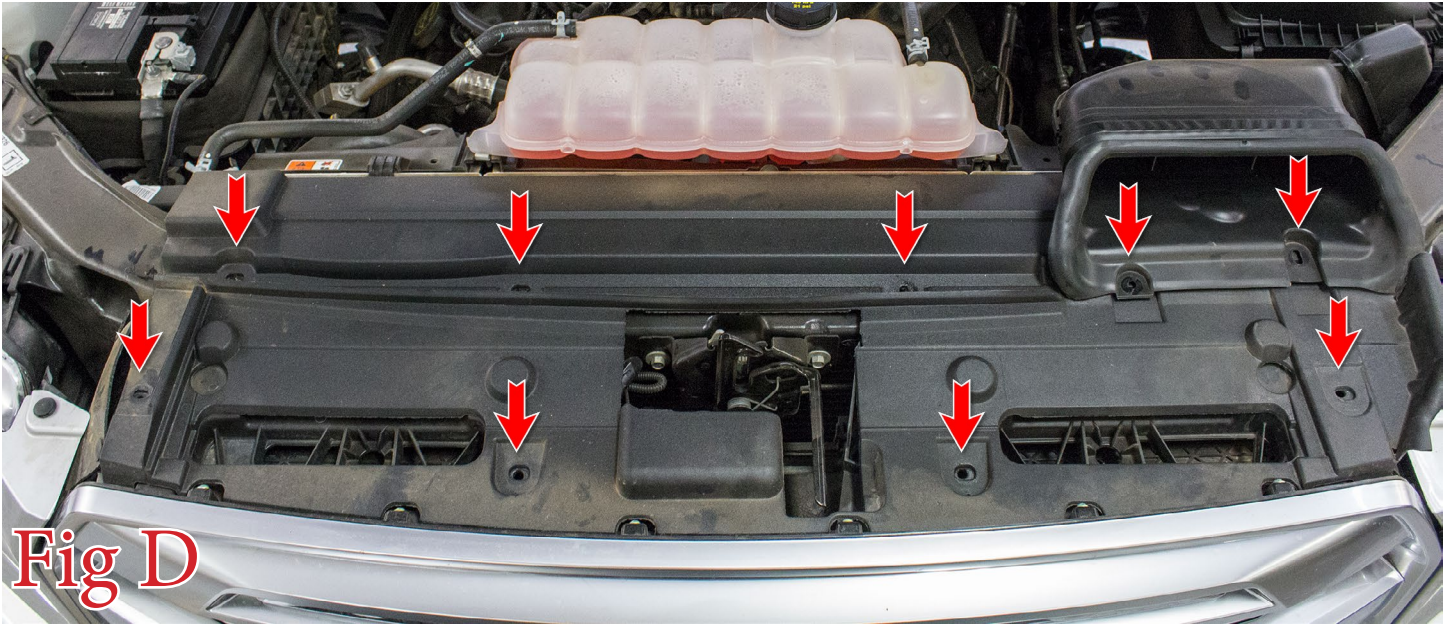
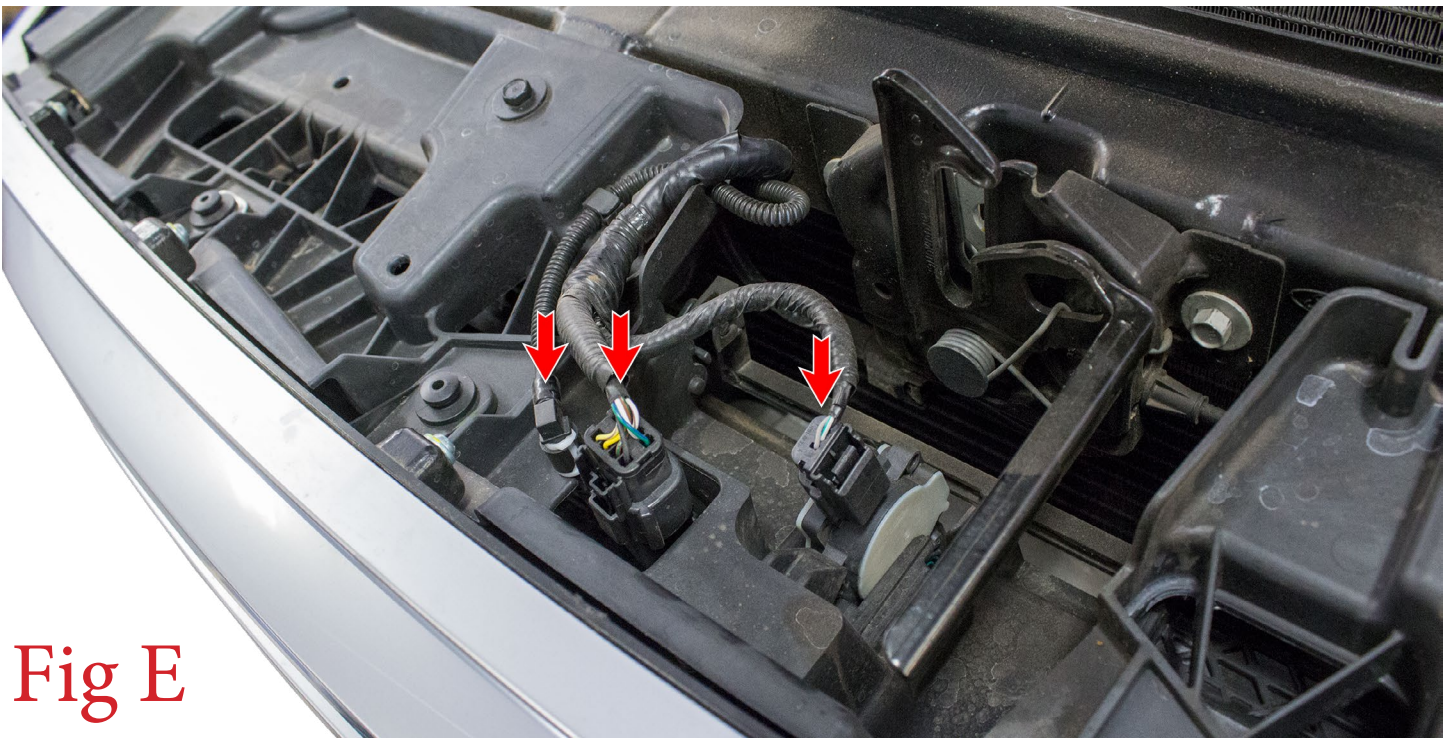

Fig C

4. Remove the clips that hold on the radiator cover (there is one more clip just to the right of where this picture cuts off). Then, remove your radiator cover. (Fig D)



5. Unplug the two connectors and undo the water line that underneath the radiator cover. (Fig E)



6. Pull the plastic clip that holds the grille harness to the grille. (Fig F)



7. Using a 10mm Socket, remove the upper grille bolts. (Fig G)



8. Remove the clip that holds on the headlight bezel. Then, pull the headlight bezel back a bit to gain access to the sides of the grille. (Fig H)

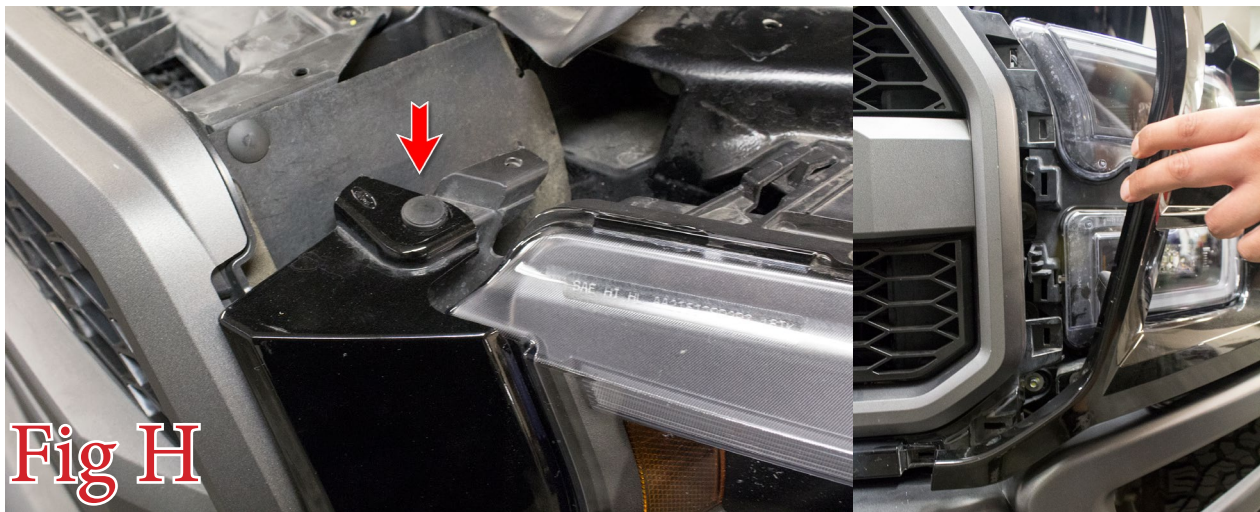

- 9. Using a 10mm Socket, remove the lower grille bolts (there is one per side). (Fig I)
- 10. Remove the clips that hold the rubber shroud to the side of the grille. There are three per side. (Fig J)

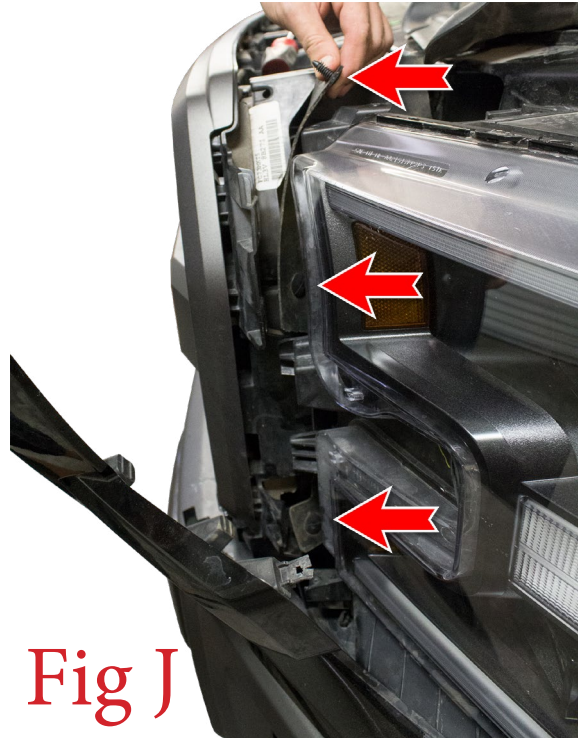

- 11. Lift the grille up and off the vehicle. There are a couple of clips that hold the front wiring harness to the grille that need to be removed as the grille is being pulled off. (Fig K)

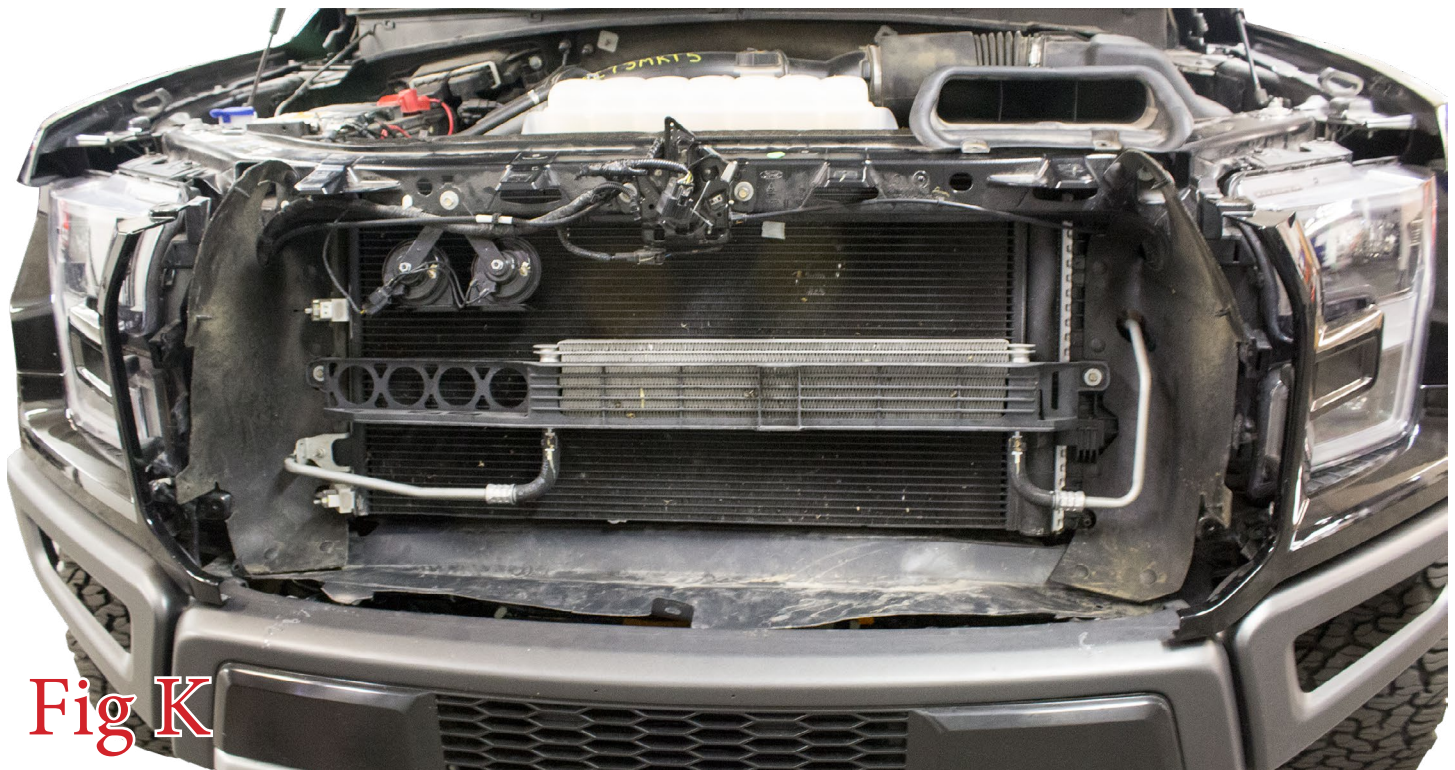

12. Remove the lower rubber shroud. There are two clips per side and three clips underneath the radiator (cannot be seen in the picture). (Fig L)

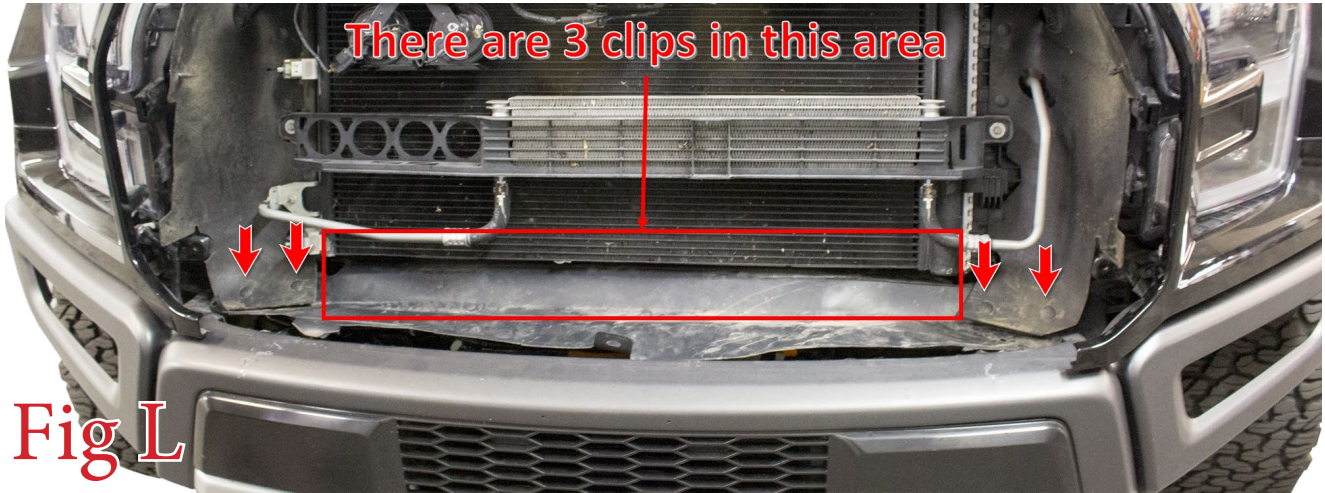

13. Using a 13mm Socket, remove the bolts that hold upper intercooler brace in place on top of the frame. There is one bolt per side. Then remove the upper intercooler brace. **Save these bolts for reuse.** (Fig M)



14. From underneath the truck, remove the intercooler fan connector. (Fig N)



15. Undo the clip for the driver side intercooler pipe and move it out of the way. Then, pull that pipe from the intercooler. (Fig O)



16. Remove the recirculation tube from the recirculation valve. (Fig P)

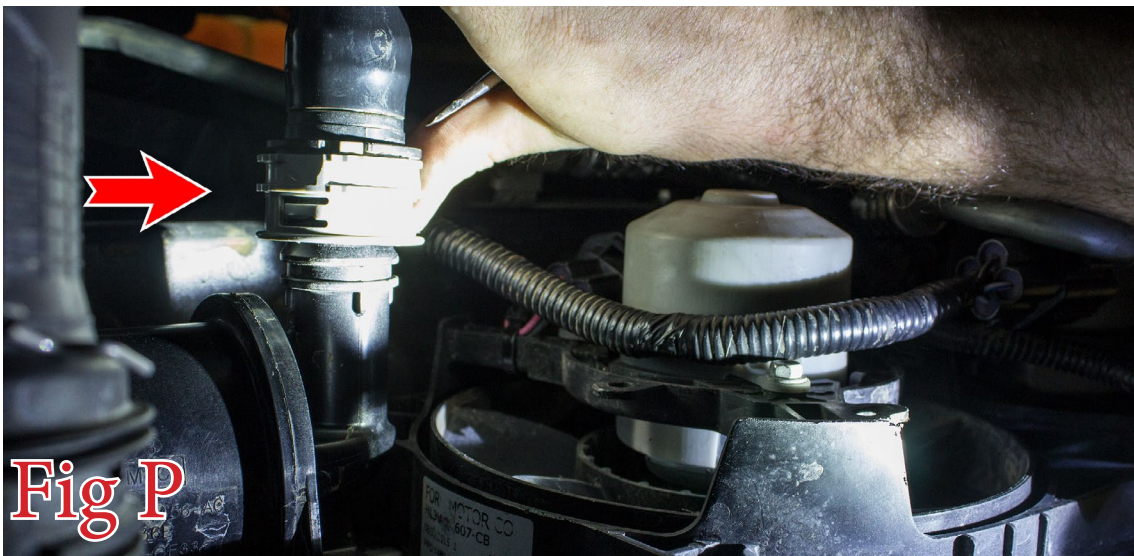

17. Using a 7mm Socket, loosen the clamps on both blue boots on the passenger side of the vehicle. Then, pull the blue boots off the pipes they are connected to. (Fig Q)

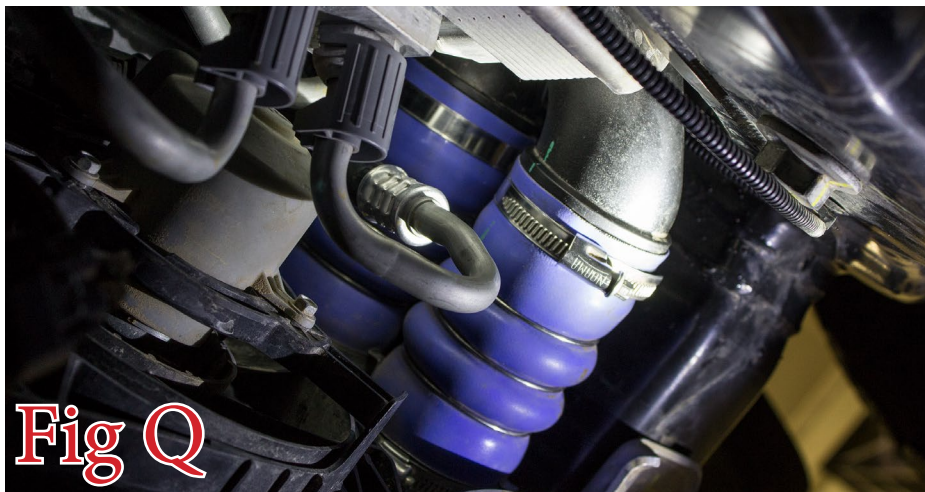

18. Using a 13mm Socket, remove the two mounting bolts for the intercooler/fan support. Then, remove this support along with the intercooler/fans. (Fig R)

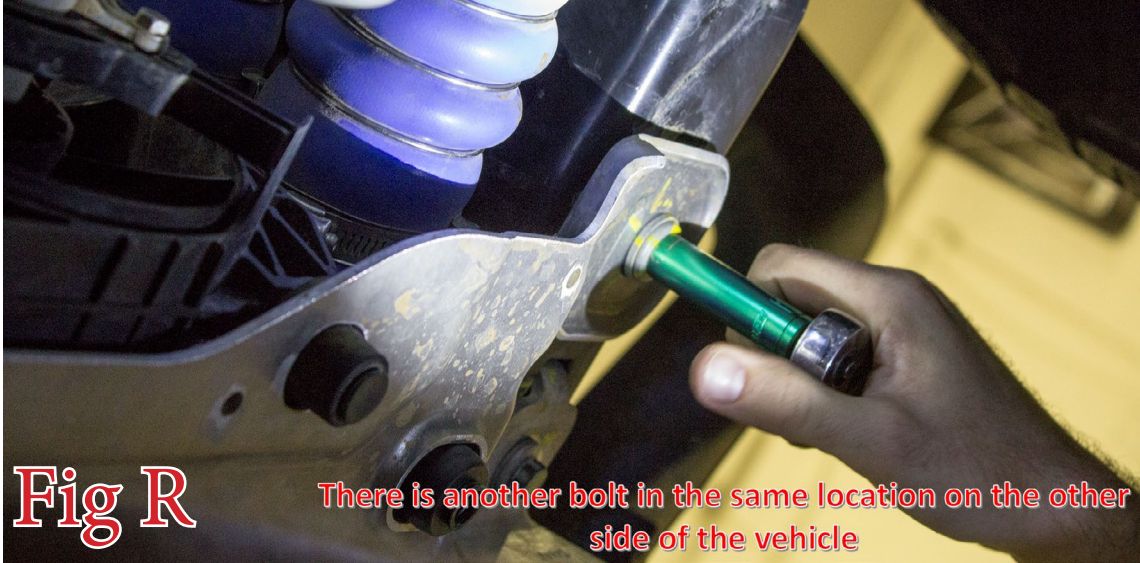

19. Using an 8mm Socket, remove the intercooler scoop mounting bolts (x4). Then, remove this scoop. The bumper off picture is just for reference, the bottom bolts are reachable with the bumper still on. You may have to use a wrench to get to them, though. (Fig S)

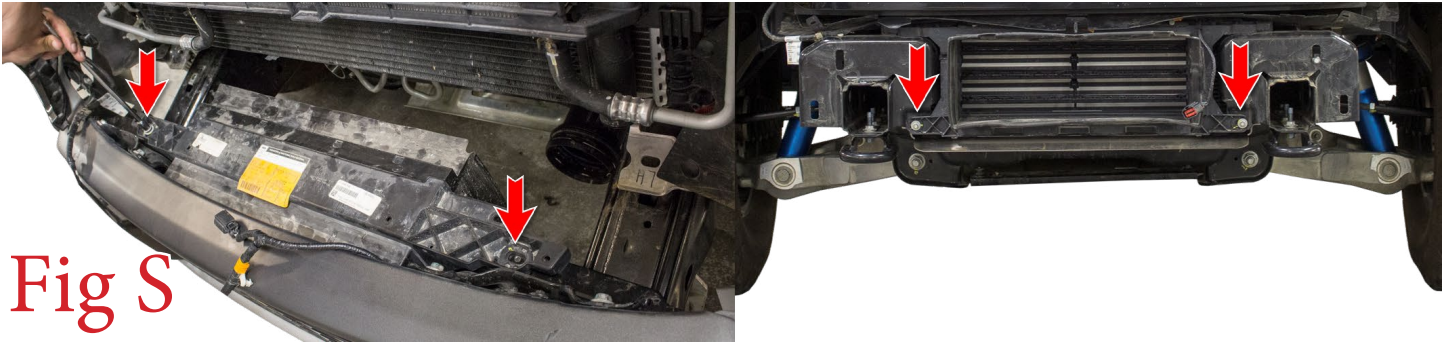

20. Follow the driver side intercooler pipe up until you see a black boot. Use a 7mm Socket to loosen the farther of the two hose clamps. Then, remove the end-pipe/boot assembly from the pipe they are connected to. (Fig T)



21. Under the hood of the truck, unplug the PCV line that is connected to the charge pipe coming off the throttle body. (Fig U)

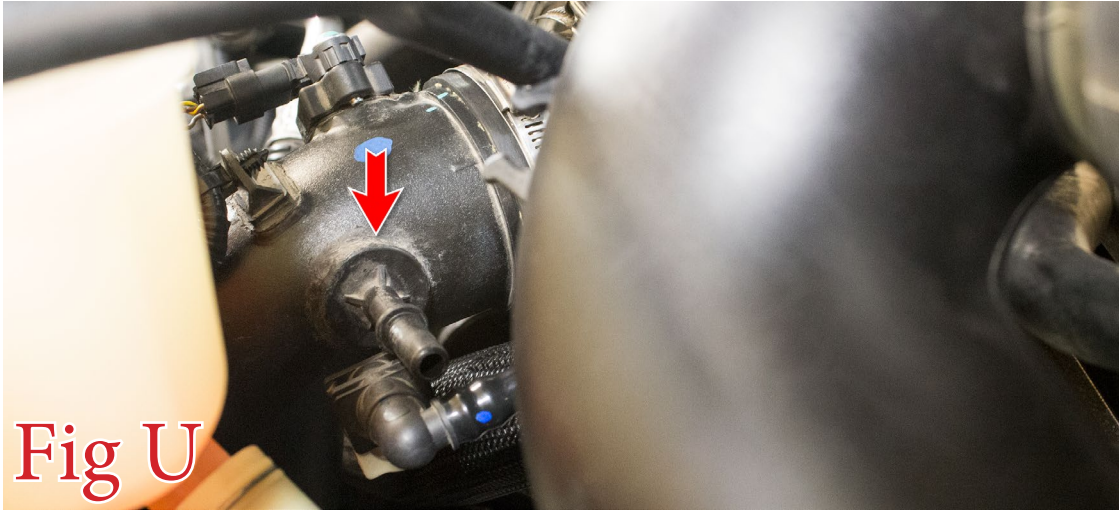

Fig U

22. Unplug the MAP sensor connector on the tube coming off your throttle body. Also, remove the plastic clip holding the sensor harness to this same pipe. (Fig V)

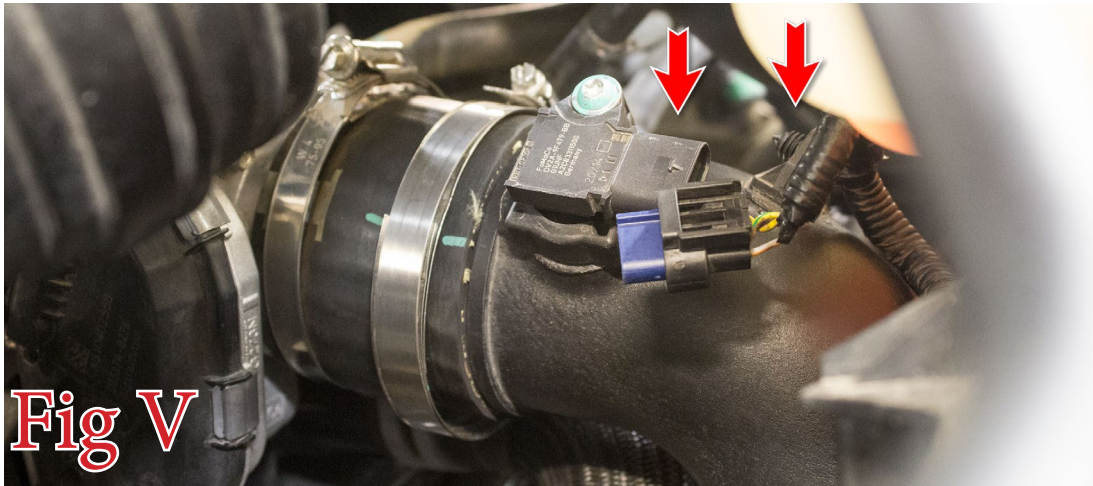

Fig V

23. Use a 7mm Socket to loosen the hose clamps for the charge pipe coming off the throttle body. Then, remove this pipe from your vehicle. (Fig W)

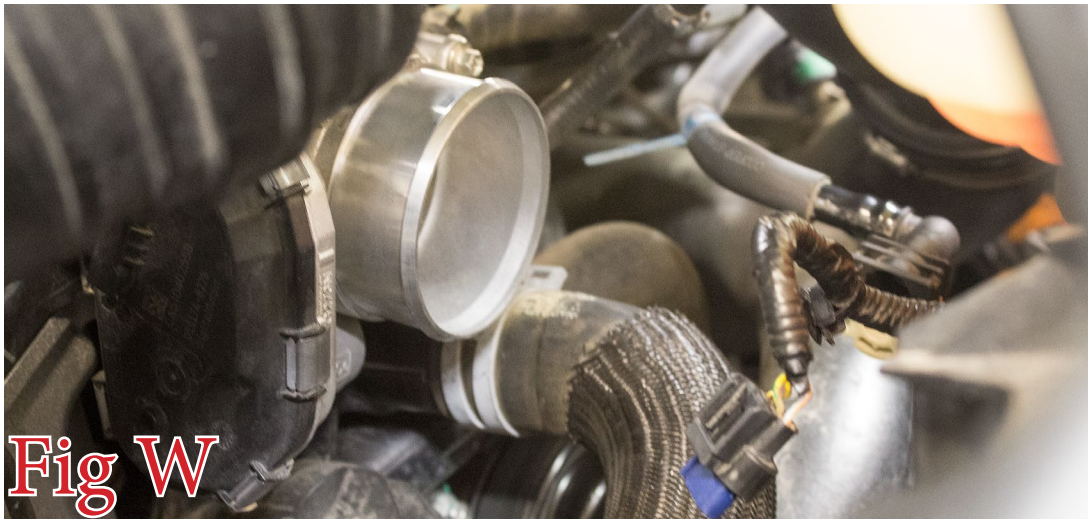
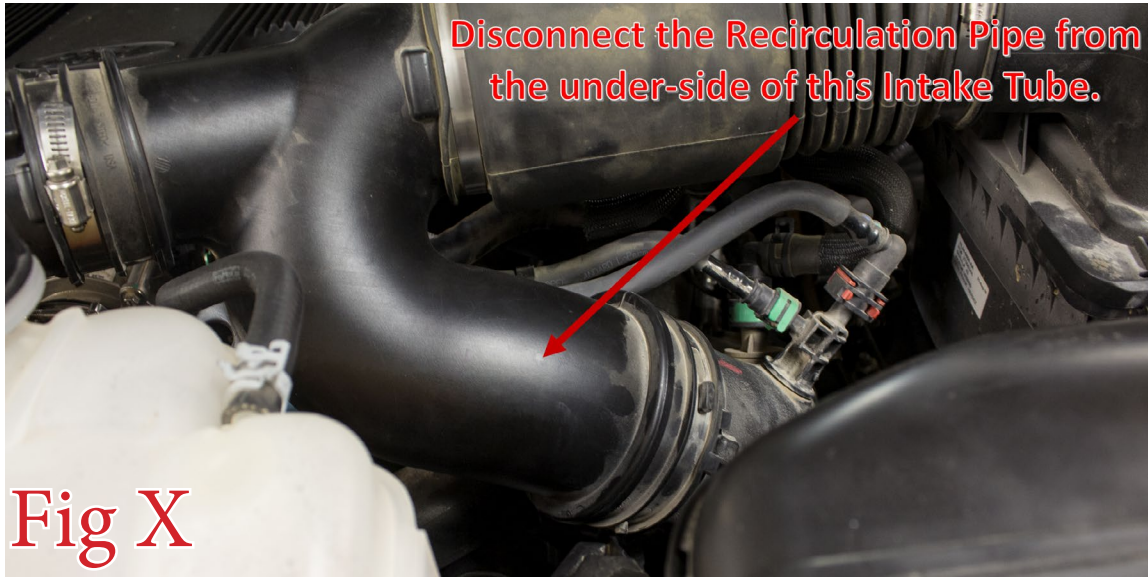
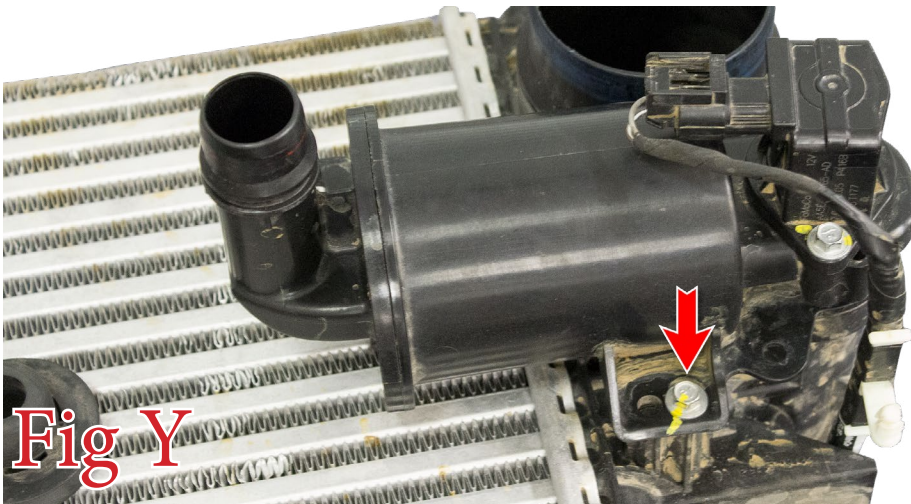

Fig W

24. Find the tube from Step 16 and follow it up until it meets your intake pipe. Remove this tube from your intake pipe. (Fig X)



25. Use an 8mm Socket to remove the recirculation valve mounting bolt. Then, remove the recirculation valve from the OEM intercooler. (Fig Z)



26. Using a cutoff wheel or something similar, trim the OEM recirculation valve. Refer to (Fig Z) for cutting instructions.



27. Find the pipe you removed in Step 23. Use a T27 Torx Bit to remove the MAP sensor mounting bolt. Then, remove the MAP sensor from that pipe. (Fig AA)



28. Use a 10mm Socket to remove the two hood latch mounting bolts. (Fig AB)

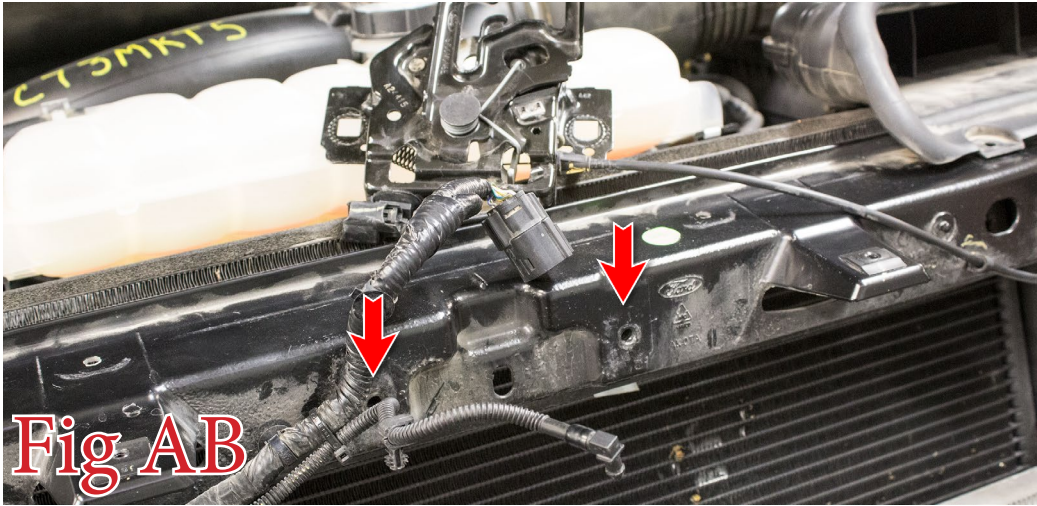

29. Use a 3mm Allen Socket to install the recirculation valve on the new intercooler piping with the supplied M4 Bolt (x1) and Washer (x1). (Fig AC)



30. Use a 5mm Allen Socket to install your MAP sensor on your new intercooler pipe using the supplied M6 Bolt (x1). (Fig AD)

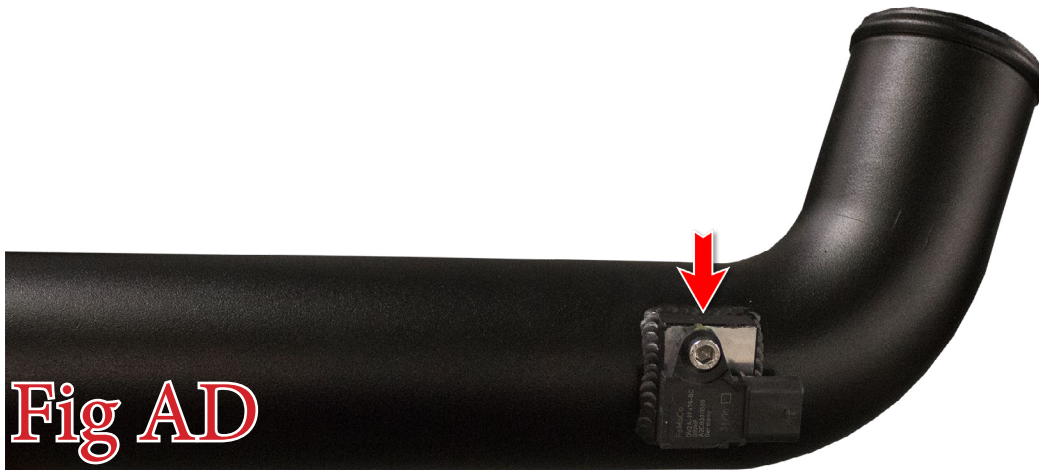

31. IF YOU DO NOT PLAN TO RELOCATE YOUR ADAPTIVE CRUISE CONTROL MODULE, PLEASE SKIP THIS STEP. Using a 7/32" Allen Socket and a 9/16" Wrench, mount your adaptive cruise control module to the relocation bracket provided. Use the supplied 3/8" Bolts (x3), 3/8" Washers (x3), and 3/8" Lock Nuts (x3). Mount the lower/left bolt with the nut on the outside. **If your adaptive cruise module does not look like the one pictured in (Fig AE), then skip to the next step.**

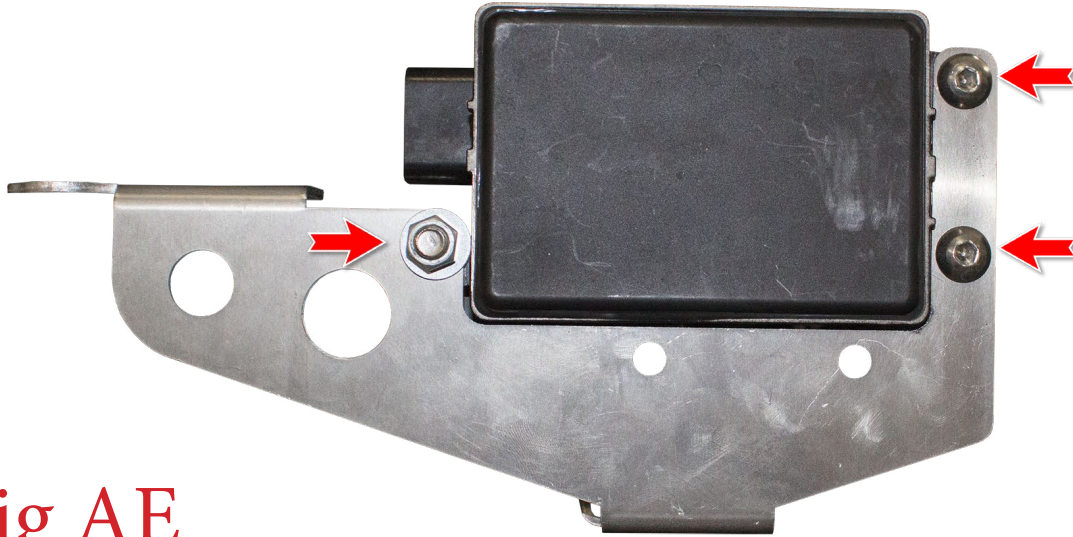

Fig AE

32. IF YOU DO NOT PLAN TO RELOCATE YOUR ADAPTIVE CRUISE CONTROL MODULE, PLEASE SKIP THIS STEP. If your adaptive cruise module does not look like the one pictured in (Fig AF), then skip to the next step. Using a 7/32" Allen Socket and 9/16" Wrench, mount your adaptive cruise control module to the relocation bracket using the additional plate that has been provided. Use the supplied 3/8" Bolts (x6), 3/8" Washers (x6), and 3/8" Lock Nuts (x6). Mount the left most bolt with the nut on the outside. **Also be sure to mount the supplied spacer in between the module/upper plate on the module's upper mounting hole (Fig AG).**

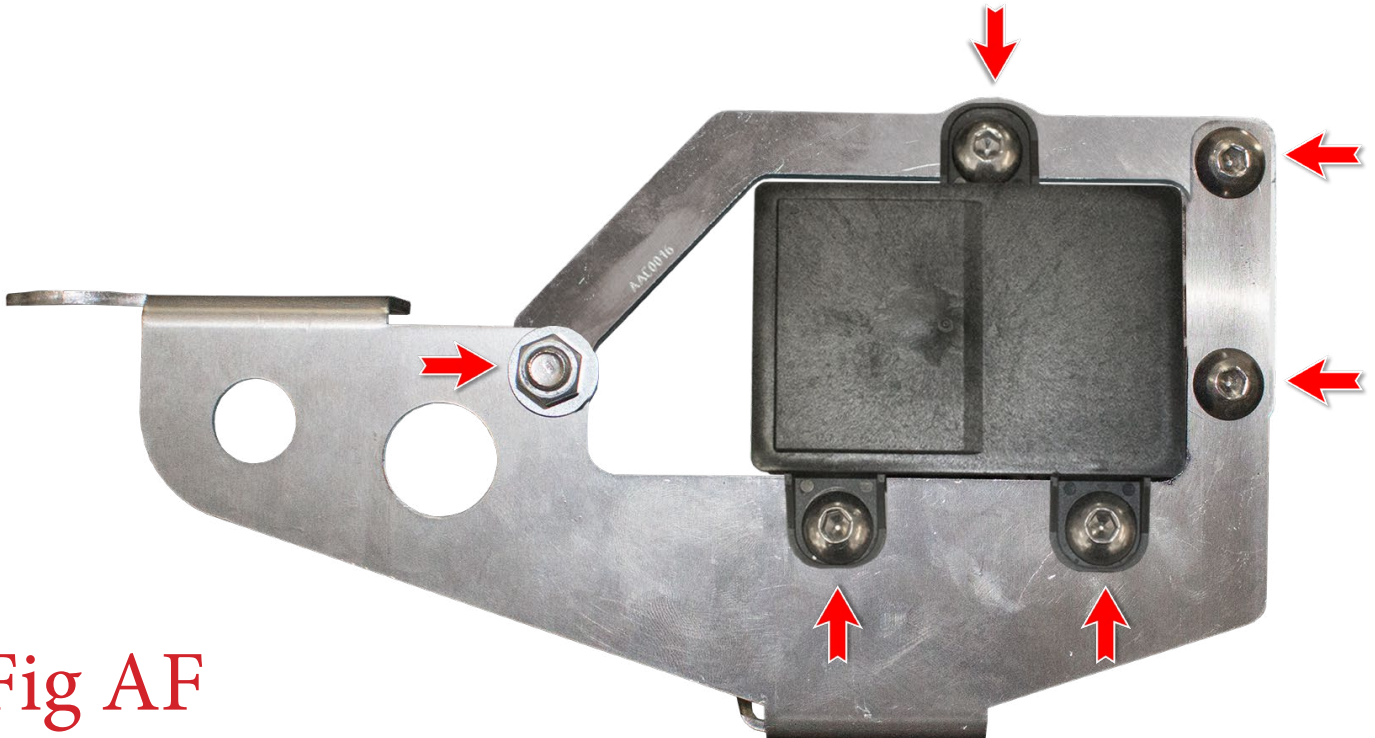
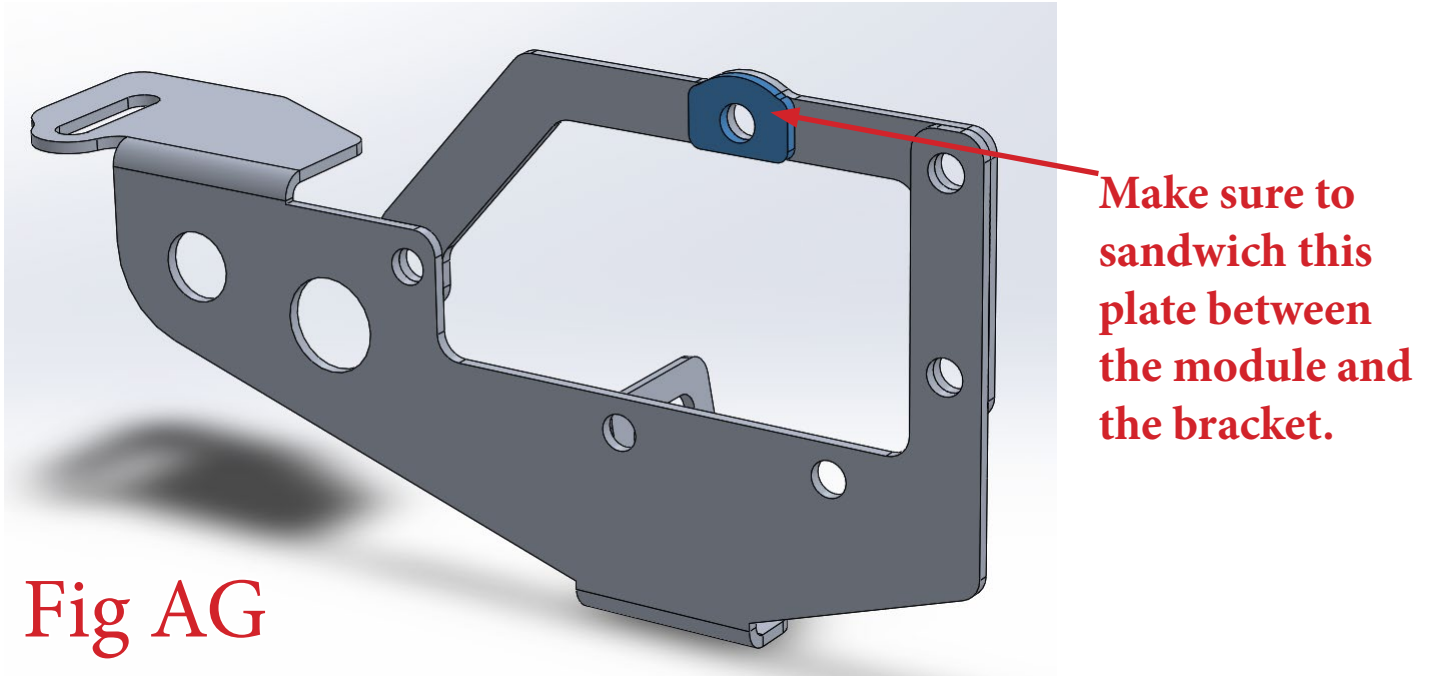
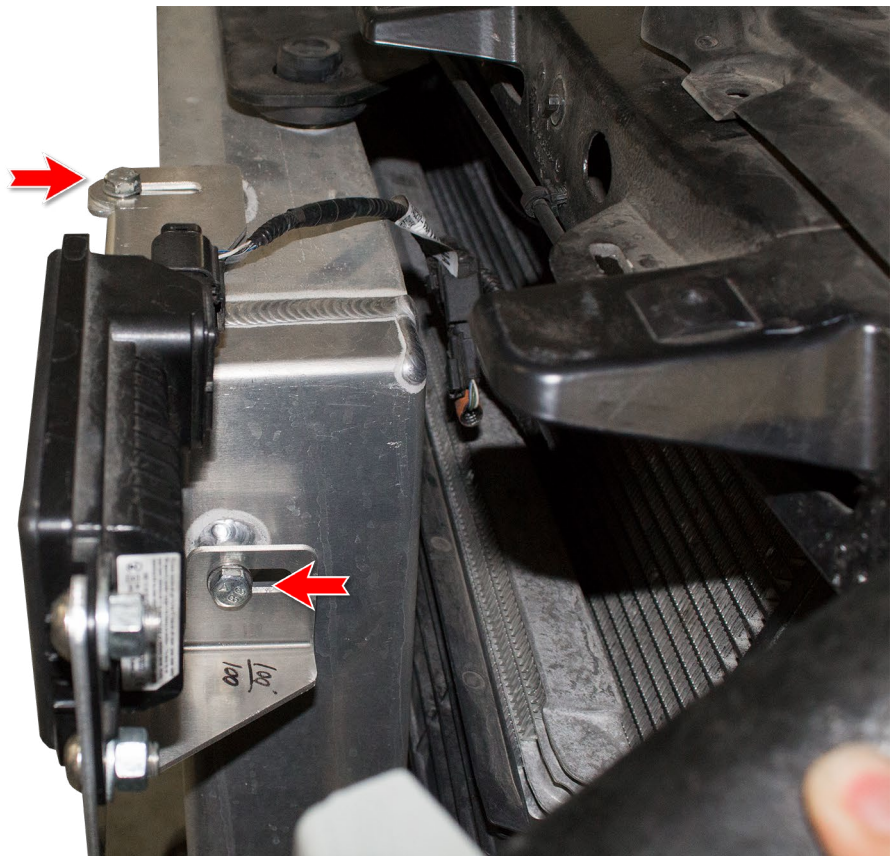

Fig AF



33. IF YOU DO NOT PLAN TO RELOCATE YOUR ADAPTIVE CRUISE CONTROL MODULE, PLEASE SKIP THIS STEP. Mount your adaptive cruise control module/bracket assembly to the intercooler. Use a 13mm Socket & Wrench along with the supplied M8 Bolts (x2), M8 Washers (x3), and M8 Lock Nut (x1). First, position the adaptive cruise module so that it is completely straight with the intercooler. Then, point it slightly towards the sky and tighten both mounting bolts. (Fig AH)





34. Remove the four rubber feet from your OEM intercooler and install them on your new intercooler. (Fig AI)

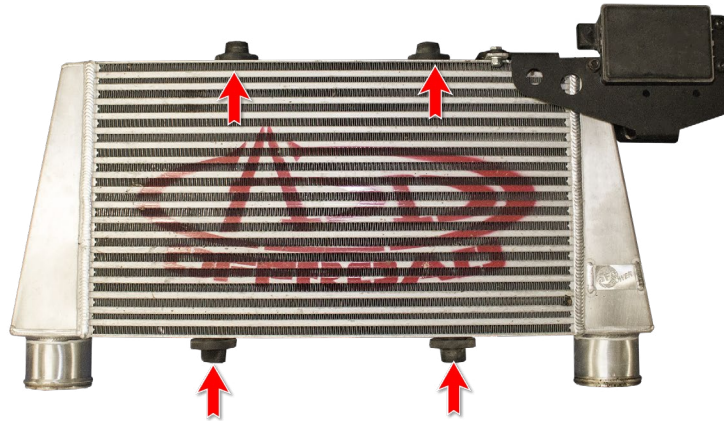

Fig AI

35. Using a 13mm Socket and the OEM bolts you removed in Step 13, install the supplied lower intercooler support. (Fig AJ)

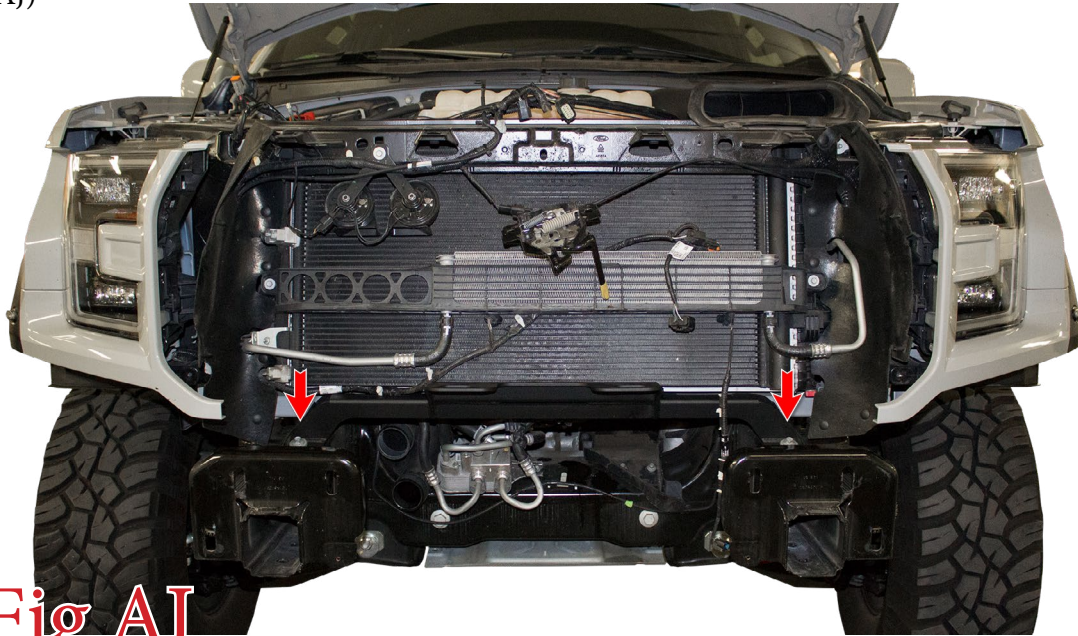

Fig AJ

36. IF YOU DO NOT PLAN TO RELOCATE YOUR ADAPTIVE CRUISE CONTROL MODULE, PLEASE SKIP THIS STEP. Use a 10mm Socket to remove the driver side trans cooler bolt so that the trans cooler is loose enough for you to pass the adaptive cruise/recirculation valve harness behind it. Once you've passed the harness behind the cooler, retighten the bolt. (Fig AK)

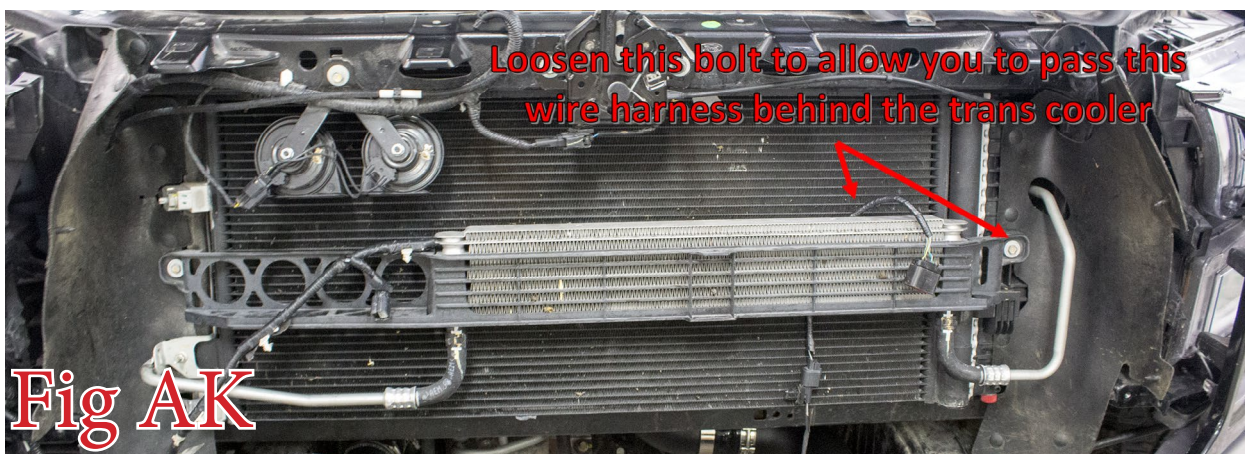

Fig AK

37. Set the new intercooler in place, so that the rubber feet sit in the openings of the lower support. Then, bolt the upper support in place. Use a 10mm Socket and the OEM hardware you removed in Step 28. Make sure to mount the upper intercooler support on the outside of the hood latch. (Fig AL)



Fig AL

38. Plug in your adaptive cruise control module. (Fig AM)

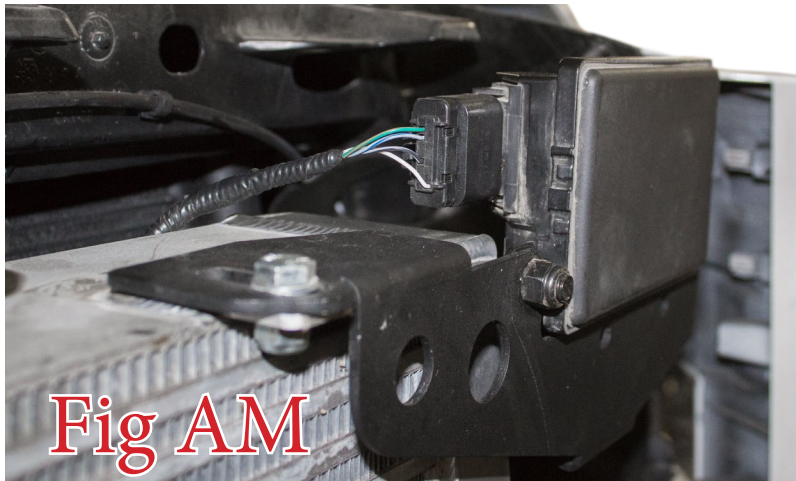

Fig AM

39. Connect your upper charge pipe (with the MAP sensor bolted to it) to your throttle body using one of the supplied straight boots with two of the supplied hose clamps. Leave the hose clamps loose for now. (Fig AN)

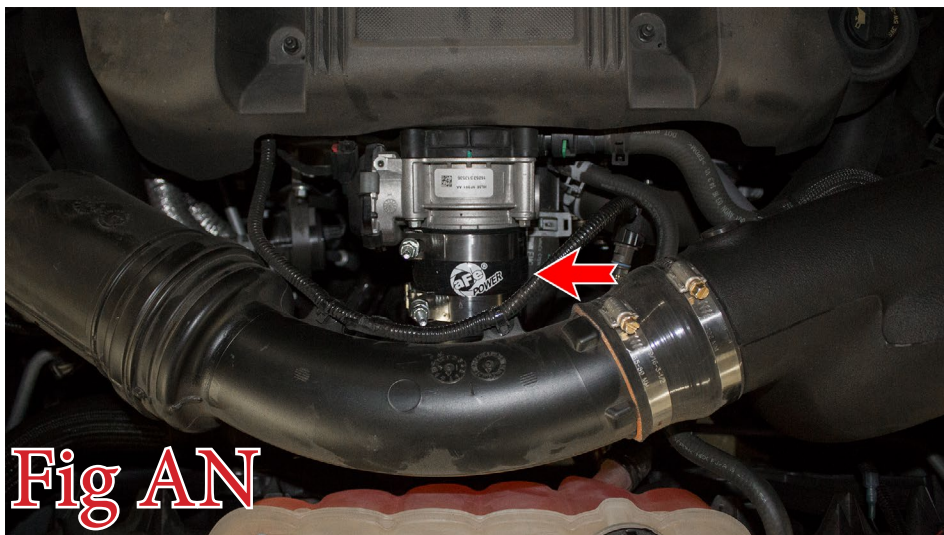

Fig AN

- 40. Plug in the MAP sensor connector and reconnect the PCV line you removed in Steps 21 & 22.
- 41. From underneath the vehicle, install your driver side charge pipe (with the recirculation valve connected to it). One end of this pipe connects to the bottom of the pipe you installed in Step 39, while the other end of this pipe connects to your new intercooler. Use one of the angled rubber boots on the intercooler connection. Use the straight boot with the bulge in it for the pipe/pipe connection. Use four of the supplied hose clamps. Once all of the boots and hose clamps are installed, use an 11mm socket to tighten the clamps you installed in this step as well as the clamps that were installed in Step 39. (Fig AO)

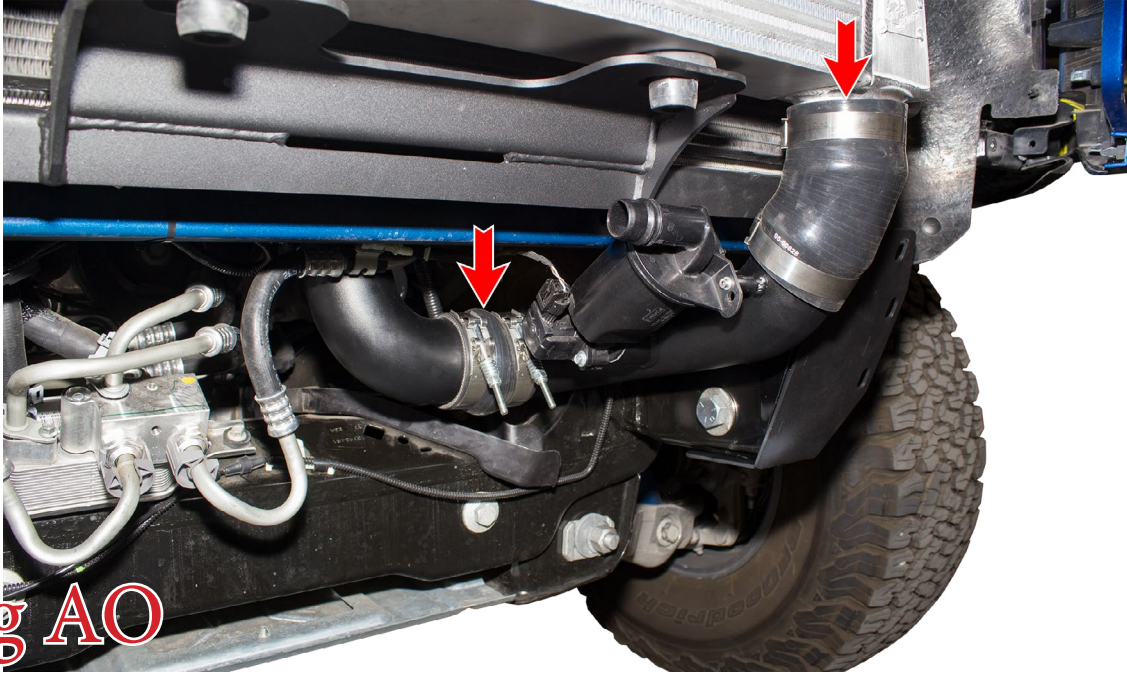

Fig AO

- 42. Plug in your recirculation valve.
- 43. Install the passenger side charge pipe. Use the two smaller boots, one angled boot, and six hose clamps. Once all of the hose clamps are loosely installed, go back and tighten them all with an 11mm socket. (Fig AP)

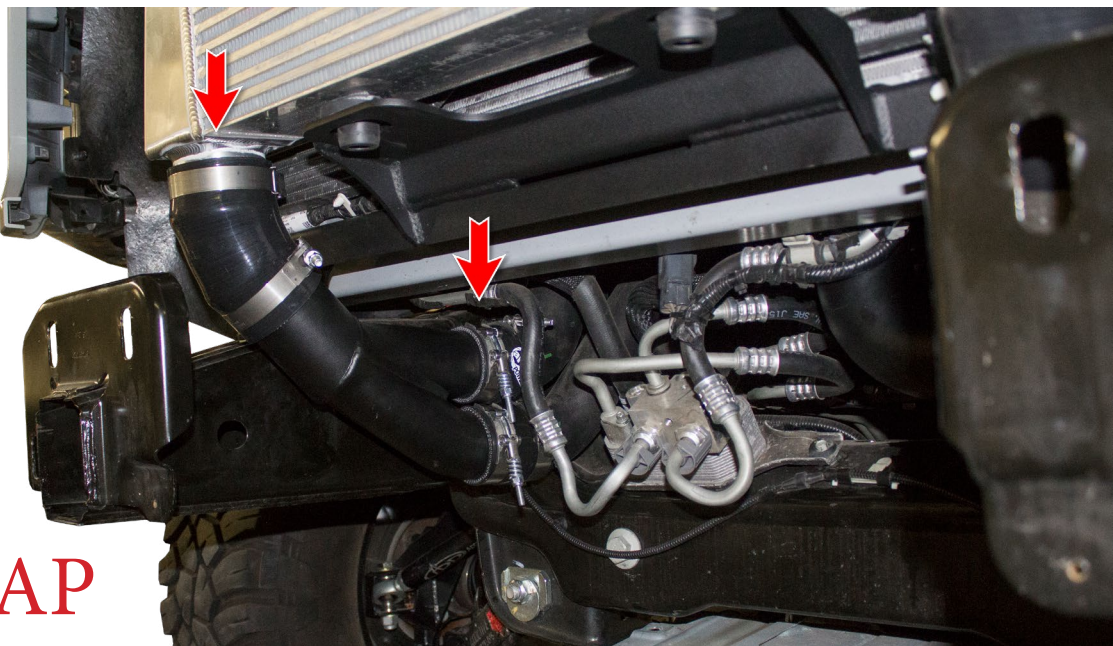

Fig AP

44. Remove all of the shutters from your grille. To do this, remove the outer peg from its holes by bending the middle portion of the shutter outwards until there is enough clearance to release the peg. Then, rotate the shutter towards the front of the grille to release the inner pegs. (Fig AQ)

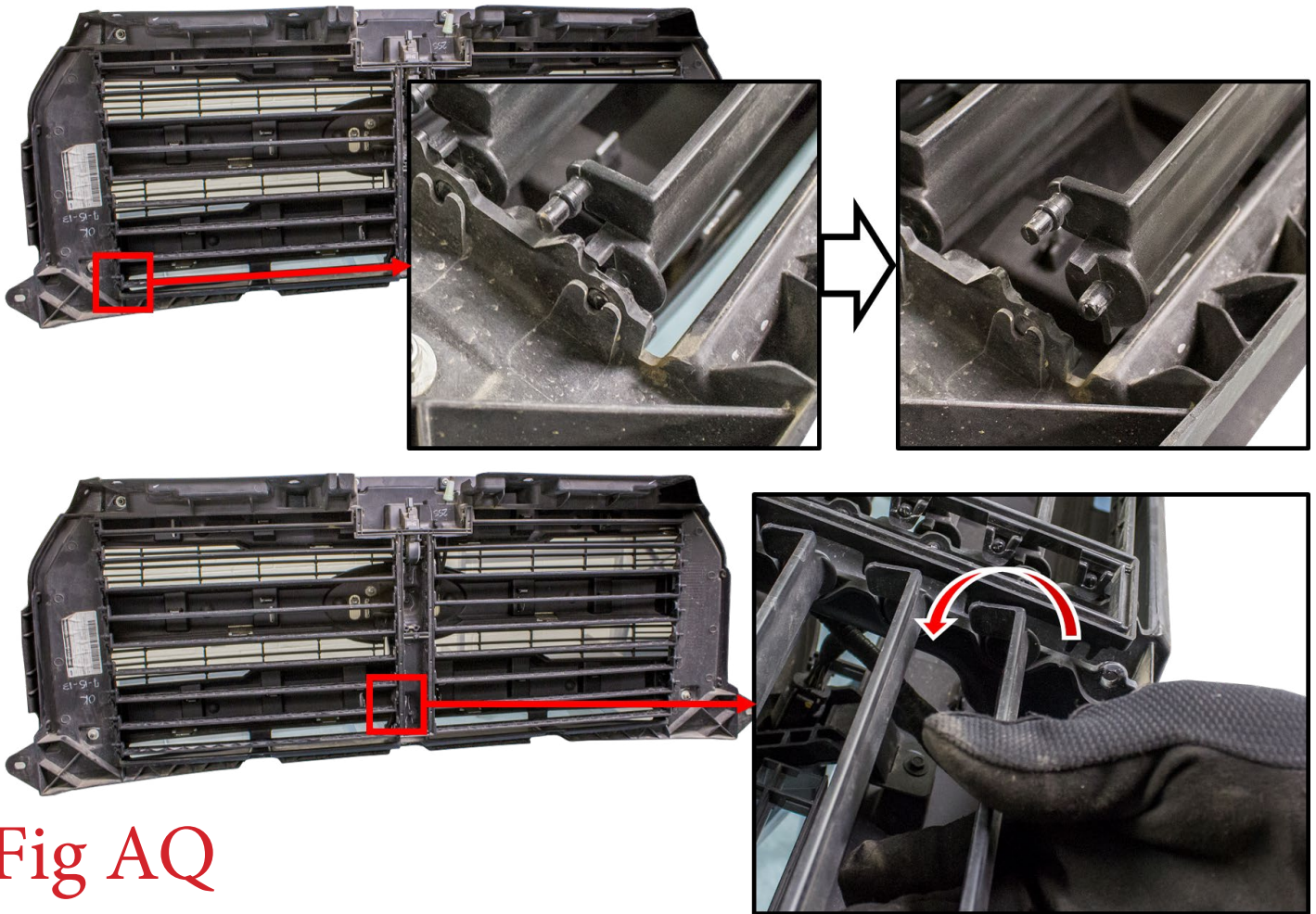

Fig AQ

45. Free the grille harness from the back side of the center rib of your grille by releasing the plastic clips that hold it on. (Fig AR)

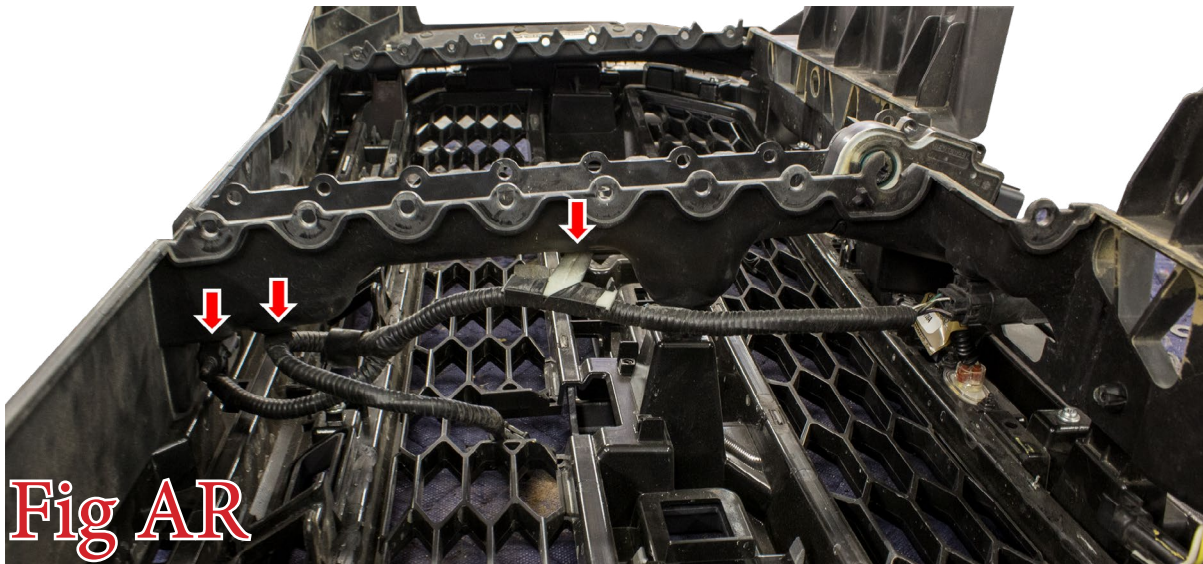
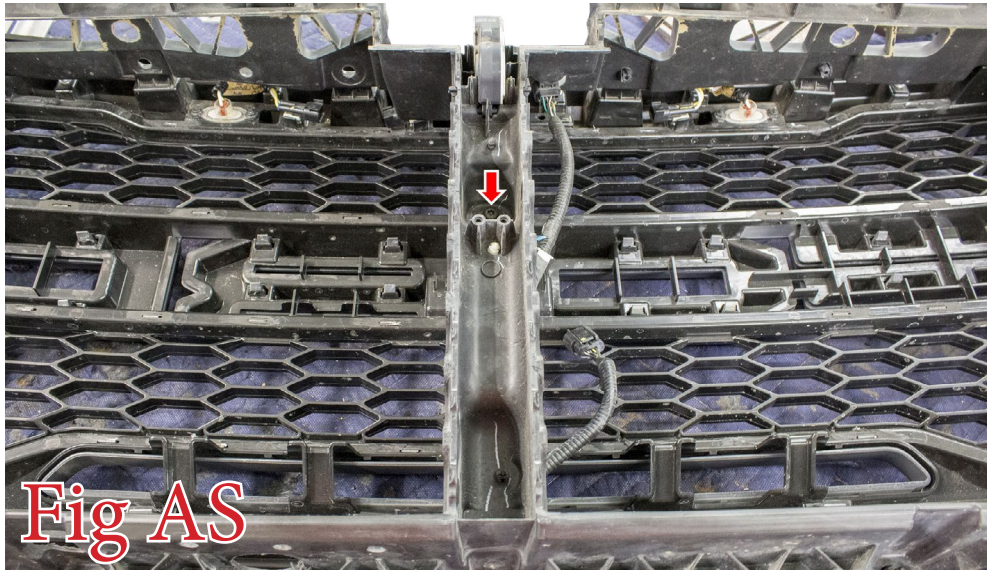
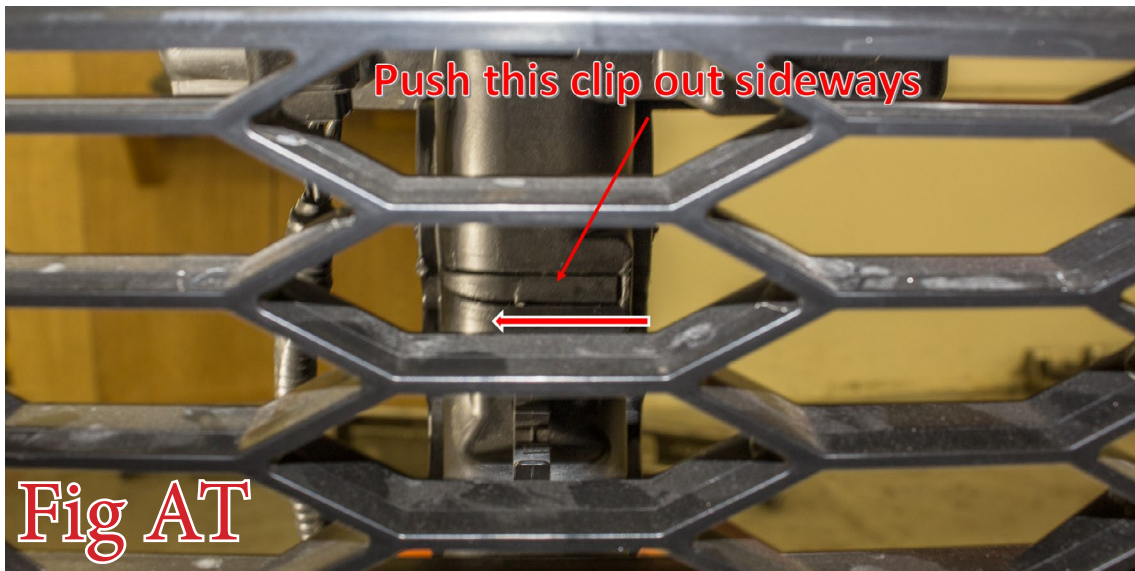

Fig AR

46. Using a T27 Torx Bit, remove the bolt that sits in the center rib of your grille. (Fig AS)



47. Remove the shutter motor from your grille. The tab on the back side of the motor pulls out from the side. Then, the motor will be free to remove. Save this motor. (Fig AT)



48. Cut the middle post off of your grille. Follow (Fig AU) as a cutting guide.

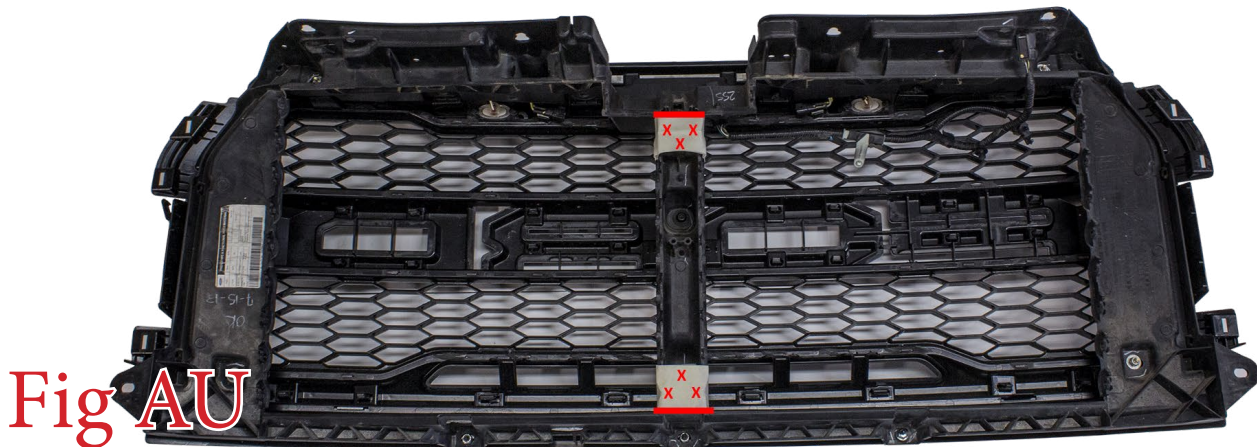

49. On the bottom of your grille, cut away about an inch of the plastic lip. We did this by starting at the center of the grille and measuring an inch from the top of the plastic lip (with the grille laying on its face) in various locations. Then, we connected all of those measurements to make a straight line. (Fig AV)

View from the Bottom

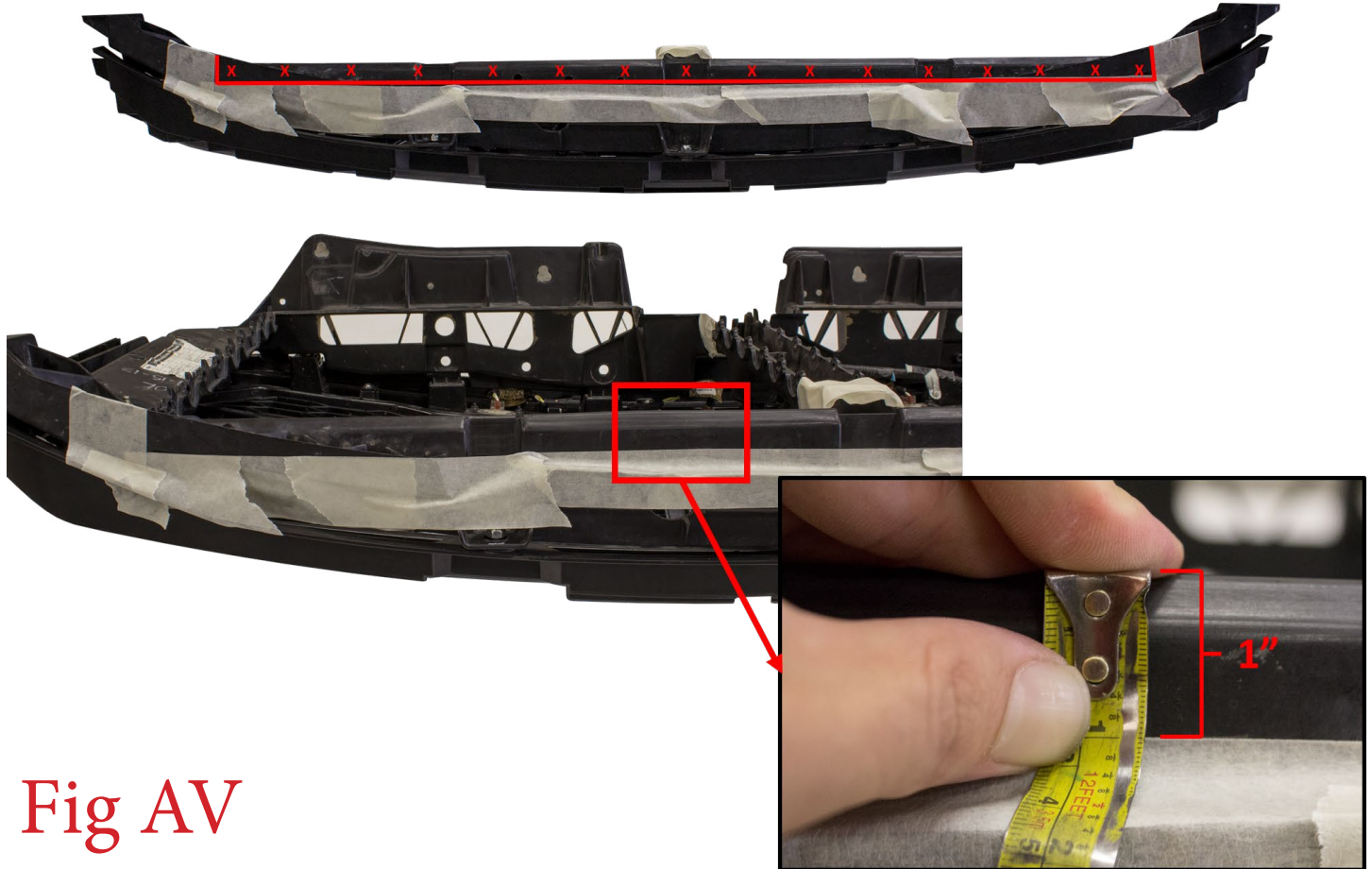
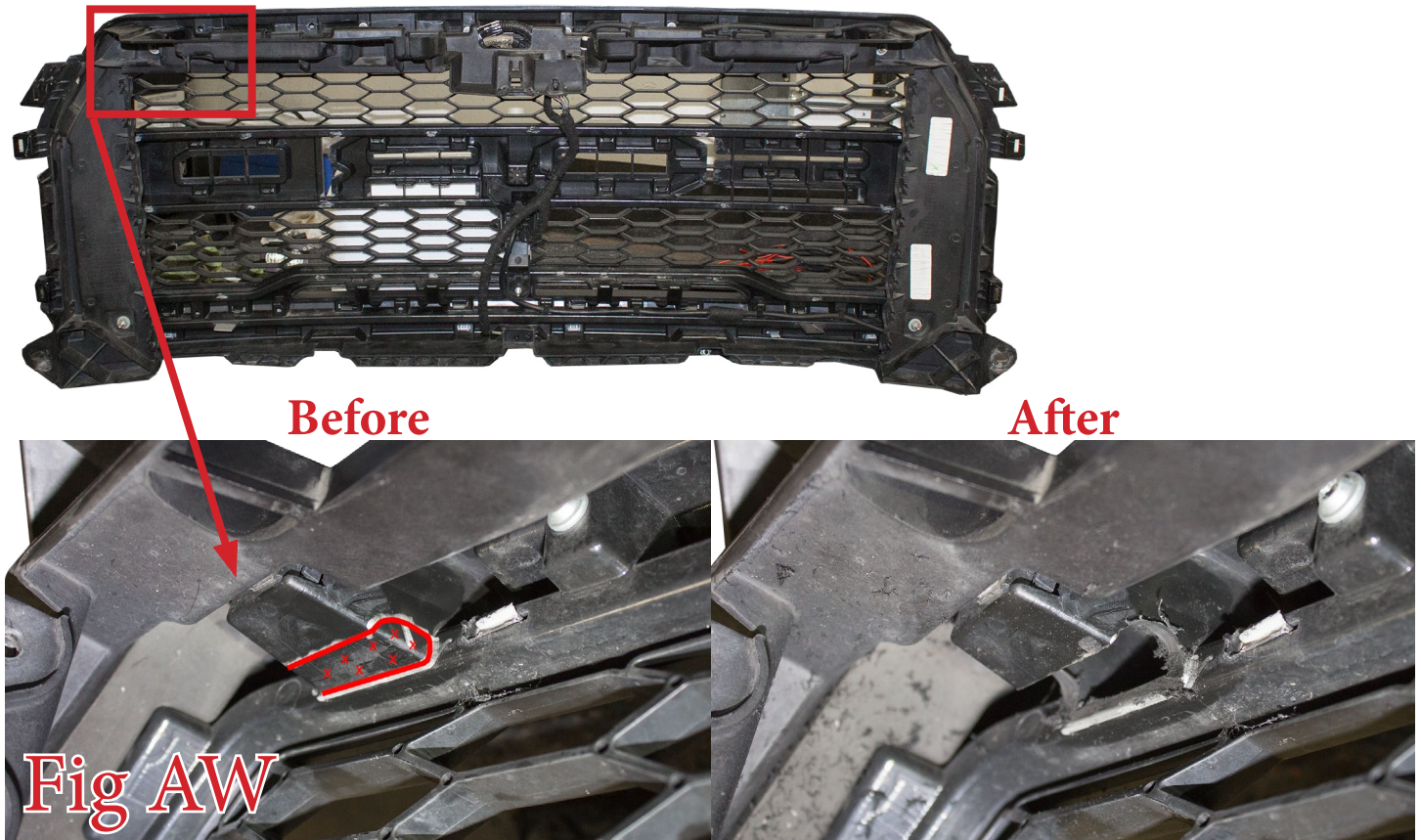

Fig AV

50. In the upper/driver side corner of the grille, trim the grill backing plate mounting tab as shown (Fig AW).



51. Take the grille shutter motor that was removed in Step 47 and plug it back into the grille harness. Zip tie this motor up and out of the way.

52. Reinstall your grille by reversing Steps 4 - 11. If your grille collides with the intercooler as you try to install it, take note and trim it further. It is normal for the grille to be touching the adaptive cruise control module. You may have to hold the grille in place as you install the lower grille bolt. (Fig AX)



53. Find the intercooler shutter motor, which is attached to the intercooler scoop that was removed in Step 19. Remove this motor from the intercooler scoop, plug it back into its original harness on the truck, then zip tie it up and out of the way. (Fig AY)

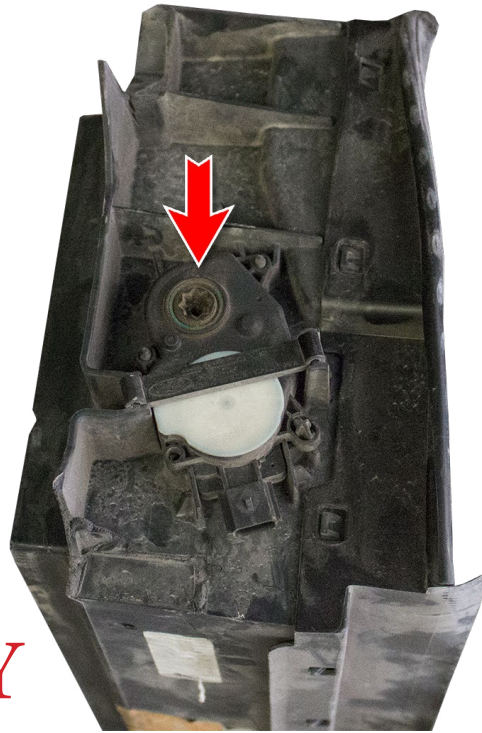

Fig AY

54. Find the supplied rubber cap and zip-tie. Use the rubber cap to cover the opening on the underside of the truck's intake tube, where you removed the recirculation tube from. (Refer to Step 24). Use the zip-tie to secure the rubber cap.

55. **IF YOU DO NOT PLAN TO RELOCATE YOUR ADAPTIVE CRUISE CONTROL MODULE, PLEASE SKIP THIS STEP.** If your adaptive cruise control module is too sensitive or not sensitive enough, you may have to make slight changes to its position. Pointing it more towards the sky will make it less sensitive, while pointing it more towards the ground will make it more sensitive. Only make small changes to the provided position measurements. **For further fine tuning of your adaptive cruise module, you may have to take it to a Ford dealer and to get recalibrated.**

56. Reinstall your skid plate and plastic front bumper piece.

57. **The hose from your factory recirculation valve does not get re-used. Your factory recirculation valve will now vent to atmosphere.**

58. Find the CARB Compliance sticker. Clean off a spot on your core support under the hood of your vehicle. Then, place this sticker in a clearly visible spot on your core support as shown in (Fig AZ).



59. Stand back and enjoy your new ADD Intercooler Kit.

60. Check and re-tighten, if needed, all mounting bolts after 100 miles and periodically thereafter.